



**A15**  
**PEDESTRIAN AND CYCLIST**  
**AREAS**





All our documents can be downloaded free of charge from: [www.nicoll.fr](http://www.nicoll.fr)

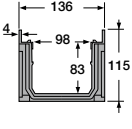

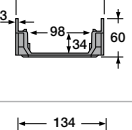

# HYDRAULIC DRAINAGE CHANNELS - A15

## Connecto® - Width 130 ext. - Separated parts

DESCRIPTION	DRAWINGS	REF.	Packing	Packaging
<b>HIGH CHANNEL</b>				
		Channel body length 1m in PP with PP edges - light grey	<b>CAN177</b>	Delivered per 6 and sold per elements
		Channel body length 1m in PP with PP edges - black	<b>KCAN177N</b>	
		End cap/end outlet - light grey		
		End cap/end or lateral outlet Ø 100	<b>NAT177</b>	10
		End cap/end or lateral outlet Ø 110	<b>NAV177</b>	10
		End cap/end outlet - black		
		End cap/end or lateral outlet Ø 100	<b>NAT177N</b>	10
		End cap/end or lateral outlet Ø 110	<b>NAV177N</b>	10



<b>SHALLOW CHANNEL</b>				
		Channel length 0,5 m in PVC with PVC edges	<b>CAB773</b>	12
		Channel length 0,5 m with trap with outlet 40 / 50 / 93	<b>CABS773</b>	6
		End or lateral outlet Ø 40	<b>NAH773</b>	10

<b>ACCESSORIES</b>				
	Vertical outlet Ø 100	<b>STCAN</b>	10	
	Vertical outlet Ø 110	<b>SVCAN</b>	10	
	Vertical or lateral outlet Ø 100	<b>STDR10</b>	10	
	Vertical or lateral outlet Ø 110	<b>SVDR10</b>	10	
	Sump unit			
	outlet Ø 100	<b>PSCVT</b>	5	
outlet Ø 110	<b>PSCVW</b>	5		

<b>PVC GRATINGS</b>								
DESCRIPTION	DRAWINGS	REF. Light grey	REF. Sand	REF. White	REF. Dark grey	Packing	Packaging	
 <b>Grating length 0,5 m with high absorption surface area</b>		<b>GRL77</b>	<b>GRL77S</b>		<b>GRL77K*</b>		12	
 <b>Grating for swimming-pool and pedestrians applications length 0,5 m</b>		<b>GR77P</b>	<b>GR77PS</b>	<b>GR77PB</b>			12	
Set of screws to fix GRL77 and GR77P on channel body - To be ordered by sets of 12 pieces		<b>FIXCAN</b>					S12	

\*Grating supplied with 2 FIXCAN

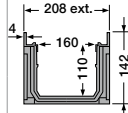

# Connecto® - Width 200 ext. - Separated parts

	DESCRIPTION	DRAWINGS	REF.	Packing	Packaging
	<b>Channel body length 1 m in PP with PP edges - light grey</b>		<b>CAN188</b>		Delivered per 4 and sold per elements
	<b>End cap/end or lateral outlet Ø 100</b>		<b>NAT188</b>		10
	<b>End cap/end or lateral outlet Ø 110</b>		<b>NAV188</b>		10
	<b>End cap/end or lateral outlet Ø 125</b>		<b>MAX188</b>		10

## ACCESSORIES

	<b>Vertical outlet Ø 125</b>		<b>SXCAN</b>		10
	<b>Sump unit</b>				
	outlet Ø 100		<b>PSCVT</b>		5
	outlet Ø 110		<b>PSCVV</b>		5

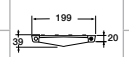
## PVC GRATING FOR CAN188

DESCRIPTION	DRAWINGS	REF. Light grey	REF. Sand	Packing	Packaging
		<b>GRL88</b>	<b>GRL88S</b>		8
	Set of screws to fix GRL88 on channel body CAN188 ( for 3 meters of channels) <i>To be ordered by sets of 12 pieces</i>	<b>FIXCAN2</b>		S12	



### DID YOU KNOW ?

#### Nicoll pool grating:

- Special pedestrian grating (class A15).
- Ideal for barefoot use (hole diameter less than 8 mm, in compliance with standard NF EN 1253).
- Possible applications in swimming pools, changing rooms and public showers.
- Resistant to UV, corrosion and chemical agents (chlorine).

GR77P

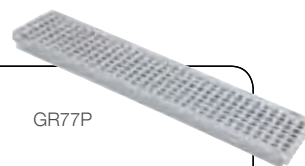

# CONNECTO<sup>®</sup>, new PVC gratings design

## Building

NEW



**Nicoll** is offering a new range of PVC gratings with updated design to match perfectly with your environment. These gratings are suitable for Connecto<sup>®</sup> drainage channel bodies of 130 mm width.

### Advantages:

- 2 models for the environment of the garden - A15
- 1 model for the environment of the garage - B125
- Colour in harmony with the ground, the facade and gutter downpipe
- Anti-Uv treated PVC grating
- Grating suitable for drainage channels bodies in compliance with NF EN 1433 standard
- Complies with disabled accessibility requirements
- Lockable grating



# HYDRAULIC DRAINAGE CHANNELS - A15

Connecto® - Width 130 ext.

	DESCRIPTION	DRAWINGS	REF.	Packing	Packaging
<b>PVC GRATING</b>					
<b>HIGH CHANNEL</b>					
	<b>Channel length 1m in PP with 2 PVC slotted gratings - light grey</b>		<b>CAN10AG*</b>		Delivered only per pallets of 32 m and sold per elements of 1 m
	<b>Pallet of 32 m (delivery unit)</b>		<b>PAN10AG</b>		
	<b>Channel length 1m in PP with 2 PVC slotted gratings - sand</b>		<b>CAN10AS*</b>		Delivered only per pallets of 32 m and sold per elements of 1 m
	<b>Pallet of 32 m (delivery unit)</b>		<b>PAN10AS</b>		
	Set of screws for gratings on CAN10AG and CAN10AS (for 3 meters of channels) <i>To be ordered by sets of 12 pieces</i>		<b>FIXCAN</b>	S12	
	<b>End cap/end or lateral outlet Ø 100</b>		<b>NAT177</b>		10
	<b>End cap/end or lateral outlet Ø 110</b>		<b>NAV177</b>		10
<b>SHALLOW CHANNEL</b>					
	<b>Channel length 0,5 m in PVC with 1 PVC grating for swimming-pool - light grey</b>		<b>CAB510APG*</b>		Delivered only per pallets of 63 m and sold per elements of 0,5 m
	<b>Pallet of 63 pieces (delivery unit)</b>		<b>PAB510APG</b>		
	<b>Channel length 0,5 m in PVC with 1 PVC grating for swimming-pool - sand</b>		<b>CAB510APS*</b>		Delivered only per pallets of 63 m and sold per elements of 0,5 m
	<b>Pallet of 63 pieces (delivery unit)</b>		<b>PAB510APS</b>		
	Set of screws for gratings on CAB510APG and CAB10APS (for 3 meters of channels) <i>To be ordered by sets of 12 pieces</i>		<b>FIXCAN</b>	S12	
	<b>End or lateral outlet Ø 40</b>		<b>NAH773</b>		10
<b>POLYAMIDE GRATING</b>					
	<b>1 PP channel length 1m + 1 PP heelguard grating</b>		<b>CAN10AHP</b>		Delivered only per pallets of 40 m and sold per elements of 1 m
	<b>Pallet of 40 pieces (delivery unit)</b>		<b>PAN10AHP</b>		
	Set of 12 screws and 12 brass inserts <i>To be ordered by sets of 12 pieces</i>		<b>FIXCANN</b>	S12	
	<b>End cap/end or lateral outlet Ø 100 mm</b>		<b>NAT177N</b>		10
	<b>End cap/end or lateral outlet Ø 110 mm</b>		<b>NAV177N</b>		10





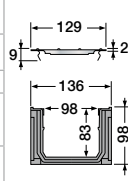
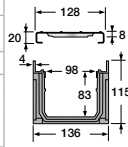
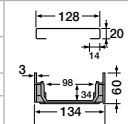

\*Available as separate parts, see page 320

# HYDRAULIC DRAINAGE CHANNELS - A15

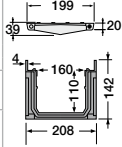
Connecto® - Width 130 ext.

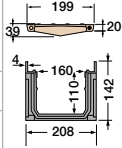
	DESCRIPTION	DRAWINGS	REF.	Packing	Packaging
<b>GALVANIZED STEEL GRATING</b>					
	<b>Black channel 1m in PP and 1 slotted galv. steel grating</b> Pallet of 56 m (delivery unit)		<b>DRP178</b>		Delivered only per pallets of 56 m and sold per elements of 1 m
			<b>PDRP178</b>		
	<b>Light grey channel 1m in PP and 1 slotted galvanized steel grating</b> Pallet of 56 m (delivery unit)		<b>DRP178G</b>		
		<b>PDRP178</b>			
	Set of screws to fix the gratings (for 6 meters of channels) <i>To be ordered by set of 12 pieces</i>			<b>FIXCAN1</b>	S12
	<b>End cap/end or lateral outlet Ø 100</b>		<b>NAT178</b>		10
	<b>End cap/end or lateral outlet Ø 110</b>		<b>NAV178</b>		10
<b>STAINLESS STEEL GRATING - 304</b>					
<b>HIGH CHANNEL</b>					
	<b>PP channel 1m with 1 slotted galvanized steel grating non lockable</b> Pallet of 32 m (delivery unit)		<b>CAN10AP</b>		Delivered only per pallets of 32 m and sold per elements of 1 m
			<b>PAN10AP</b>		
	<b>PP channel 1m with 1 stainless steel slotted grating non lockable</b> Pallet of 32 m (delivery unit)		<b>CAN10API</b>		
		<b>PAN10API</b>			
	<b>PP channel 1m with 1 stainless steel perforated grating</b> Pallet of 32 m (delivery unit)			<b>CAN10ATI</b>	
		<b>PAN10ATI</b>			
Set of screws to fix the gratings CAN10ATI (for 6 meters of channels) <i>To be ordered by set of 12 pieces</i>			<b>FIXCAN3</b>	S12	
	<b>End cap/end or lateral outlet Ø 100</b>		<b>NAT177</b>		10
	<b>End cap/end or lateral outlet Ø 110</b>		<b>NAV177</b>		10
<b>SHALLOW CHANNEL</b>					
	<b>PVC channel 1m with 1 stainless steel slotted grating non lockable</b> Pallet of 32 m (delivery unit)		<b>CAB10API</b>		Delivered only per pallets of 32 m and sold per elements of 1 m
			<b>PAB10API</b>		
	<b>CAB10API with stainless steel edges</b>		<b>CABI10API</b>		
	<b>PVC channel 1m with stainless steel performed grating</b> Pallet of 32 m (delivery unit)		<b>CAB10ATI</b>		
		<b>PAB10ATI</b>			
		<b>CAB10ATI with stainless steel edges</b>		<b>CABI10ATI</b>	
<b>CAB10ATI with 316 stainless steel grating</b> for corrosive area			<b>CAB10ATI316</b>		
Set of screws to fix the gratings CAB10ATI (for 6 meters of channels) <i>To be ordered by set of 12 pieces</i>			<b>FIXCAN3</b>	S12	
	<b>End cap/end or lateral outlet</b>		<b>NAH773</b>		10
<b>ACCESSORIES</b>					
	<b>Vertical outlet Ø 100</b>		<b>STCAN</b>		10
	<b>Vertical outlet Ø 110</b>		<b>SVCAN</b>		10
	<b>Lateral or vertical outlet Ø 100</b>		<b>STDR10</b>		10
	<b>Lateral or vertical outlet Ø 110</b>		<b>SVDR10</b>		10
	<b>Sump unit outlet Ø 100</b>		<b>PSCVT</b>		5
	<b>Sump unit outlet Ø 110</b>		<b>PSCVV</b>		5

# Connecto® - Width 200 ext.

	DESCRIPTION	DRAWINGS	REF.	Packing	Packaging
<b>PVC GRATING</b>					
	<b>Channel length 1 m in PP with 2 PVC slotted gratings - light grey</b>		<b>CAN15AG**</b>		Delivered only per pallets of 30 m and sold per elements of 1 m
	<b>Pallet of 30 m (delivery unit)</b>		<b>PAN15AG</b>		
	<b>Channel length 1 m in PP with 2 PVC slotted gratings - sand</b>		<b>CAN15AS**</b>		Delivered only per pallets of 30 m and sold per elements of 1 m
	<b>Pallet of 30 m (delivery unit)</b>		<b>PAN15AS</b>		
	Set of screws to fix the gratings on CAN15AG and CAN15AS (for 3 meters of channels) <i>To be ordered by set of 12 pieces</i>		<b>FIXCAN2</b>	S12	
	<b>End cap/end or lateral outlet Ø 100</b>		<b>NAT188</b>		10
	<b>End cap/end or lateral outlet Ø 110</b>		<b>NAV188</b>		10
	<b>End cap/end or lateral outlet Ø 125</b>		<b>NAX188</b>		10
<b>ACCESSORIES</b>					
	<b>Vertical outlet</b>				
	Ø 125		<b>SXCAN</b>		10
	<b>Sump unit</b>				
	<b>Outlet Ø 100</b>		<b>PSCVT</b>		5
	<b>Outlet Ø 110</b>		<b>PSCVV</b>		5

\*\*Available as separate parts, see page 321



## INNOVATION

Irrespective of the model:

- A full stainless steel finish available on request: stainless steel grating + edges.
- Optional 316 stainless steel grating available on request: designed for corrosive environments (seaside areas).

# CONNECTO® shallow channel 3 m length

Building

NEW



**Nicoll** is innovating and proposes a new generation of unique drainage channels on the market: a wide range of drainage channels. Measuring 5 cm in height and 3 m in length, its installation is quick and easy thanks to its carefully designed accessories. In compliance with EN 1433 standard, this PVC channel collects run-off water. Nicoll offers you a wide range of well-designed and aesthetic gratings. Nicoll: a solution for each project !

## Advantages:

- Durability
- Even longer: less single points to deal with
- Reduced height: solves the issue of small obstruction
- Excellent UV-resistance of PVC associated grating
- Complies with disabled accessibility requirements
- Attractive: perfect alignment of the channel line
- 100 % recyclable





# HYDRAULIC DRAINAGE CHANNELS - A15

Connecto® - Width 130 ext.

	DESCRIPTION	DRAWINGS	REF.	Packing	Packaging
<b>PVC CHANNEL 3 m length</b>					
	<b>Shallow channel width 130, 3 METERS length dark grey</b>		<b>CAB133A</b>		4 lengths (12 ml)
<b>ASSOCIATED GRATINGS A15</b>					
	<b>1 m galvanized steel slotted grating</b>		<b>GDR10AP</b>		Delivered only per pallets of 84 m and sold per elements of 1 m
	<b>Pallet of 84 meters (delivery unit)</b>		<b>PFGDR10AP</b>		
	<b>1 m heel polypropylene grating - black</b>		<b>GDR10AHPP</b>		
	<b>Pallet of 84 meters (delivery unit)</b>		<b>PFGDR10AHPP</b>		
	<b>1 m stainless steel slotted grating</b>		<b>GDR10API</b>		per unit
	<b>1 m 304 stainless steel perforated grating</b>		<b>GDR10ATI</b>		per unit
	<b>PVC grating for swimming-pool and pedestrians applications length 0,50 m - light grey</b>		<b>GR77P</b>	12	
	<b>PVC grating for swimming-pool and pedestrians applications length 0,50 m - white</b>		<b>GR77PB</b>	12	
	<b>PVC grating for swimming-pool and pedestrians applications length 0,50 m - sand</b>		<b>GR77PS</b>	12	
	<b>PVC grating with high absorption capacity length 0,50 m - light grey</b>		<b>GRL77</b>	12	
	<b>PVC grating with high absorption capacity length 0,50 m - white</b>		<b>GRL77S</b>	12	
	<b>ASSOCIATED GRATINGS B125</b>				
	<b>PVC grating length 0,50 m - light grey</b>		<b>GR77</b>		
	<b>PVC grating length 0,50 m - sand</b>		<b>GR77S</b>		
<b>ACCESSORIES</b>					
	<b>End outlet - diameter 40/50 - dark grey</b>		<b>NAHJ13A</b>		10
	<b>Junction for CAB133A</b>		<b>JCAB13</b>		10
	<b>Vertical outlet - Ø 100</b>		<b>STCAB13</b>		10
	<b>Vertical outlet - Ø 110</b>		<b>SVCAB13</b>		10
	<b>Locking set with galvanized screws</b>		<b>FIXCAB13</b>	S6	

SANITARY

DRAINAGE FITTINGS

SANITARY

GLUE

RAINGUTTERS

ROOFING ACCESSORIES

FASCIA AND ROOFING SOFFIT BOARDS

ACCES TRAP DOOR

VENTILATION

SURFACE DRAINAGE PRODUCTS

HYDRAULIC DRAINAGE CHANNELS

HYDRAULIC DRAINAGE CHANNELS







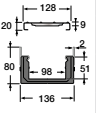

SAUL

BUILDING

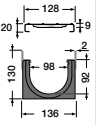
ENVIRONMENT

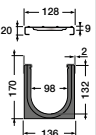

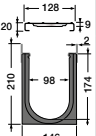

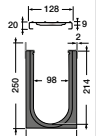

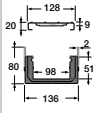

# HYDRAULIC DRAINAGE CHANNELS- A15

## Kenadrain® HD - Width 100 int.

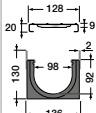
	DESCRIPTION	DRAWINGS	REF.	Packing	Packaging
<b>GALVANIZED STEEL GRATING</b>					
<b>PARK CHANNEL</b>					
	<b>Channel length 1 m with galvanized steel edges and 1 galvanized steel slotted grating</b> <b>Height 1 - 0,80 mm</b> Locking: 2 screws per grating on galvanized locking bar		<b>DR100AP</b>		Delivered only per pallets of 40 m and sold per elements of 1 m
	<b>Pallet of 40 m</b> (delivery unit)		<b>PR100AP</b>		
<b>STEPPED-FALL CHANNEL</b>					
	<b>Channel length 1 m with galvanized steel edges and 1 galvanized steel slotted grating</b> <b>Height 1 - 130 mm</b> Locking: 2 screws per grating on galvanized locking bar		<b>DR101AP</b>		Delivered only per pallets of 40 m and sold per elements of 1 m
	<b>Pallet of 40 m</b> (delivery unit)		<b>PR101AP</b>		
	<b>Channel length 1 m with galvanized steel edges and 1 galvanized steel slotted grating</b> <b>Height 2 - 170 mm</b> Locking: 2 screws per grating on galvanized locking bar		<b>DR102AP</b>		Delivered only per pallets of 40 m and sold per elements of 1 m
	<b>Pallet of 40 m</b> (delivery unit)		<b>PR102AP</b>		
	<b>Channel length 1 m with galvanized steel edges and 1 galvanized steel slotted grating</b> <b>Height 3 - 210 mm</b> Locking: 2 screws per grating on galvanized locking bar		<b>DR103AP</b>		Delivered only per pallets of 35 m and sold per elements of 1 m
	<b>Pallet of 35 m</b> (Delivery unit)		<b>PR103AP</b>		
	<b>Channel length 1 m with galvanized steel edges and 1 galvanized steel slotted grating</b> <b>Height 4 - 250 mm</b> Locking: 2 screws per grating on galvanized locking bar		<b>DR104AP</b>		Delivered only per pallets of 28 m and sold per elements of 1 m
	<b>Pallet of 28 m</b> (Delivery unit)		<b>PR104AP</b>		

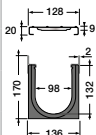
Possibility of stainless steel edge on request and 316 stainless steel grating

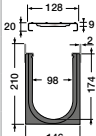

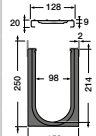

## Kenadrain® HD - Width 100 int.

	DESCRIPTION	DRAWINGS	REF.	Packing	Packaging
<b>STAINLESS STEEL GRATING - 304</b>					
<b>PARK CHANNEL</b>					
	<b>Channel length 1m with stainless steel edges and 1 stainless steel slotted grating</b> <b>Height 1 - 0,80 mm</b> Locking: 2 screws per grating on stainless locking bar		<b>DRI100API</b>		Delivered only per pallets of 40 m and sold per elements of 1 m
	<b>Pallet of 40 m</b> (Delivery unit)		<b>PRI100API</b>		
<b>STEPPED-FALL CHANNEL</b>					
	<b>Channel length 1m with stainless steel edges and 1 stainless steel slotted grating</b> <b>Height 1 - 130 mm</b> Locking: 2 screws per grating on stainless locking bar		<b>DRI101API</b>		Delivered only per pallets of 40 m and sold per elements of 1 m
	<b>Pallet of 40 m</b> (Delivery unit)		<b>PRI101API</b>		
	<b>Channel length 1m with stainless steel edges and 1 stainless steel slotted grating</b> <b>Height 2 - 170 mm</b> Locking: 2 screws per grating on stainless locking bar		<b>DRI102API</b>		Delivered only per pallets of 40 m and sold per elements of 1 m
	<b>Pallet of 40 m</b> (Delivery unit)		<b>PRI102API</b>		
	<b>Channel length 1m with stainless steel edges and 1 stainless steel slotted grating</b> <b>Height 3 - 210 mm</b> Locking: 2 screws per grating on stainless locking bar		<b>DRI103API</b>		Delivered only per pallets of 35 m and sold per elements of 1 m
	<b>Pallet of 35 m</b> (Delivery unit)		<b>PRI103API</b>		
	<b>Channel length 1m with stainless steel edges and 1 stainless steel slotted grating</b> <b>Height 4 - 250 mm</b> Locking: 2 screws per grating on stainless locking bar		<b>DRI104API</b>		Delivered only per pallets of 28 m and sold per elements of 1 m
	<b>Pallet of 28 m</b> (Delivery unit)		<b>PRI104API</b>		

Possibility of stainless steel edge on request and 316 stainless steel grating

# HYDRAULIC DRAINAGE CHANNELS - A15

## Kenadrain® HD - Width 100 int.

	DESCRIPTION	DRAWINGS	REF.	Packing	Packaging
<b>ACCESSORIES</b>					
	<b>End cap/end outlet</b>				
	Height 2 - Ø 100		<b>NTDR102</b>		
	Height 2 - Ø 110		<b>NVDR102</b>		
	<b>Outlet</b> (delivered with screws)				
	Lateral or vertical Ø 100		<b>STDR10</b>		10
	Lateral or vertical Ø 110		<b>SVDR10</b>		10
	Lateral or vertical Ø 125		<b>SXDR10</b>		10
	Lateral or vertical Ø 160		<b>SZDR20</b>		10
<b>SECURITY LOCKING SYSTEM</b>					
	<b>Set of 24 security bolts</b>		<b>VISDRI</b>	S1	
	<b>Security lock key</b>		<b>CLEDRI</b>	S1	
<b>SUMP</b>					
	<b>Ekso sump with lower outlet</b>				
	width 100 - outlet Ø 125		<b>PS100X</b>		4
	width 100 - outlet Ø 110		<b>PS100V</b>		4
	<b>Ekso sump with upper outlet</b>				
	width 100 - outlet Ø 125		<b>PS100XH</b>		
	width 100 - outlet Ø 110		<b>PS100VH</b>		

# B125

PEDESTRIAN AREAS AND  
TRAFFIC CAR PARKS



All our documents can be downloaded free of charge from: [www.nicoll.fr](http://www.nicoll.fr)

# HYDRAULIC DRAINAGE CHANNELS - B125

## Connecto® - Width 130 ext. - Separated parts

	DESCRIPTION	DRAWINGS	REF.	Packing	Packaging
<b>HIGH CHANNEL</b>					
	Channel length 1m in PP with PP edges - light grey		<b>CAN177</b>		Delivered per 6 and sold per elements
	Channel length 1m in PP with PP edges - black		<b>KCAN177N</b>		
	<b>End cap/end outlet - light grey</b>				
	End cap/end or lateral outlet Ø 100		<b>NAT177</b>		10
	End cap/end or lateral outlet Ø 110		<b>NAV177</b>		10
	<b>End cap/end outlet - black</b>				
	End cap/end or lateral outlet Ø 100		<b>NAT177N</b>		10
	End cap/end or lateral outlet Ø 110		<b>NAV177N</b>		10
<b>SHALLOW CHANNEL</b>					
	Channel length 0,5 m in PVC with PVC edges		<b>CAB773</b>		12
	Channel length 0,5 m with trap outlet 40 / 50 / 93		<b>CABS773</b>		6
	<b>End cap/end or lateral outlet Ø 40</b>		<b>NAH773</b>		10
<b>ACCESSORIES</b>					
	<b>Vertical outlet Ø 100 - light grey</b>		<b>STCAN</b>		10
	<b>Vertical outlet Ø 110 - light grey</b>		<b>SVCAN</b>		10
	<b>Vertical outlet Ø 100 - black</b>		<b>STDR10</b>		10
	<b>Vertical outlet Ø 110 - black</b>		<b>SVDR10</b>		10
	<b>Sump unit</b>				
	outlet Ø 100		<b>PSCVT</b>		5
	outlet Ø 110		<b>PSCVV</b>		5

### PVC GRATING

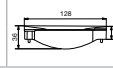
	DESIGNATION	DRAWINGS	REF. Light grey	REF. Sand	Packing	Packaging
	Standard grating length 0,5 m		<b>GR77</b>	<b>GR77S</b>		12
	Set of screws to fix the gratings GR77 (for 3 meters of channels) <i>To be ordered by set of 12 pieces</i>		<b>FIXCAN</b>		S12	

Possibility of 304 stainless steel edge on request

# Connecto® - Width 200 ext. - Separated parts

	DESCRIPTION	DRAWINGS	REF.	Packing	Packaging
	Channel length 1m in PP with PP edges - light grey		<b>CAN188</b>		Delivered per 4 and sold per elements
	End cap/end or lateral outlet Ø 100		<b>NAT188</b>		10
	End cap/end or lateral outlet Ø 110		<b>NAV188</b>		10
	End cap/end or lateral outlet Ø 125		<b>NAX188</b>		10
<b>ACCESSORIES</b>					
	Vertical Outlet Ø 125		<b>SXCAN</b>		10
	Sump unit Outlet Ø 100		<b>PSCVT</b>		5
	Outlet Ø 110		<b>PSCVV</b>		5
<b>PVC GRATING FOR CAN188</b>					
	Reinforced PVC cover length 0,5m		<b>TR88</b>		6

# Connecto<sup>®</sup> drainage channel with B125 L130 polyamide grating

## Building

NEW



Nicoll's range of drainage channels has expanded and now includes the CAN10BN drainage channel, complete with polyamide grating. This class B125 product is the ideal solution for use at garage entrances and other traffic areas.

### Advantages :

- Anticorrosion: polyamide grating reinforced with fibreglass
- Robust and light: can withstand wheel loads
- Attractive: black mesh design. UV-resistant
- High hydraulic capacity
- Safe: complies with PRM accessibility requirements, screw-mounted grating
- Easy to install
- Watertight system

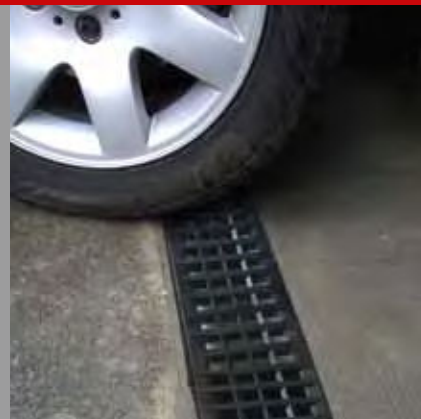



# HYDRAULIC DRAINAGE CHANNELS - B125







Connecto® - Width 130 ext.

	DESCRIPTION	DRAWINGS	REF.	Packing	Packaging
<b>POLYAMIDE GRATING</b>					
	<b>Channel length 1 m in PP with 2 polyamide gratings, locked on channel body - black</b> <b>Pallet of 32 m (Delivery unit)</b>		<b>CAN10BN</b>		Delivered per pallet of 32 m and sold per elements of 1 m
			<b>PAN10BN</b>		
	<b>End cap/end or lateral outlet</b>				
	End cap/end or lateral outlet Ø 100		<b>NAT177N</b>		10
	End cap/end or lateral outlet Ø 110		<b>NAV177N</b>		10
<b>End cap/end outlet</b>					
End cap/end outlet Ø 100		<b>STDR10</b>			
End cap/end outlet Ø 110		<b>SVDR10</b>			
<b>PVC GRATING</b>					
	<b>Channel length 1 m in PP and 2 PVC slotted gratings light grey</b> <b>Pallet of 32 m (Delivery unit)</b>		<b>CAN10BG**</b>		Delivered per pallet of 32 m and sold per elements of 1 m
			<b>PAN10BG</b>		
	<b>Channel Length 1 m in PP and 2 PVC slotted gratings sand</b> <b>Pallet of 32 m (Delivery unit)</b>		<b>CAN10BS**</b>		Delivered per pallet of 32 m and sold per elements of 1 m
			<b>PAN10BS</b>		
	Set of screws to fix the gratings on CAN10BG and CAN10BS (for 3 meters of channels) <i>To be ordered by set of 12 pieces</i>		<b>FIXCAN</b>	S12	
<b>End cap/end or lateral outlet</b>					
End cap/end or lateral outlet Ø 100		<b>NAT177</b>			10
End cap/end or lateral outlet Ø 110		<b>NAV177</b>			10
<b>GALVANIZED STEEL GRATING</b>					
<b>HIGH CHANNEL</b>					
	<b>Channel length 1 m in PP and 1 galvanized steel mesh grating - non lockable</b> <b>Pallet of 32 m (Delivery unit)</b>		<b>CAN10BC</b>		Delivered per pallet of 32 m and sold per elements of 1 m
			<b>PAN10BC</b>		
<b>SHALLOW CHANNEL</b>					
	<b>Channel length 1 m in PVC and 1 galvanized steel mesh grating - non lockable</b> <b>Pallet of 32 m (Delivery unit)</b>		<b>CAB10BC</b>		Delivered per pallet of 32 m and sold per elements of 1 m
			<b>PAB10BC</b>		

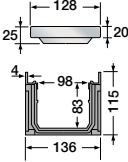
\*\*Available as separate parts, see page 332

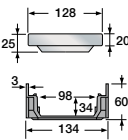
# HYDRAULIC DRAINAGE CHANNELS - B125

Connecto® - Width 130 ext.







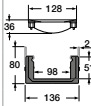

	DESCRIPTION	DRAWINGS	REF.	Packing	Packaging
<b>STAINLESS STEEL CHANNEL - 304</b>					
<b>HIGH CHANNEL</b>					
	<b>Channel length 1m in PP with 1 stainless steel mesh grating - non lockable</b>		<b>CAN10BCI</b>		Delivered only per pallets of 32 m and sold per elements of 1 m
	<b>Pallet of 32 m</b> (Delivery unit)		<b>PAN10BCI</b>		
	<b>CAN10BCI with stainless steel edges</b>		<b>CANI10BCI</b>		
	<b>End cap/end or lateral outlet</b>				
	End cap/end or lateral outlet Ø 100		<b>NAT177</b>		10
	End cap/end or lateral outlet Ø 110		<b>NAV177</b>		10
<b>SHALLOW CHANNEL</b>					
	<b>Channel length 1m in PVC with 1 stainless steel mesh grating - non lockable</b>		<b>CAB10BCI</b>		Delivered only per pallets of 32 m and sold per elements of 1 m
	<b>Pallet of 32 m</b> (Delivery unit)		<b>PAB10BCI</b>		
	<b>CAB10BCI with stainless steel edge</b>		<b>CABI10BCI</b>		
	<b>End cap/end or lateral outlet Ø 40</b>		<b>NAH773</b>		10
<b>DUCTILE IRON GRATING</b>					
	<b>Channel length 1m in PP with 2 ductile iron slotted gratings, locked on channel body</b>		<b>CAL10BF</b>		Delivered only per pallets of 56 m and sold per elements of 1 m
	<b>Pallet of 56 m</b> (Delivery unit)		<b>PAL10BF</b>		
	<b>End cap/end or lateral outlet</b>				
	End cap/end or lateral outlet Ø 100		<b>NAT178</b>		10
	End cap/end or lateral outlet Ø 110		<b>NAV178</b>		10
<b>ACCESSORIES</b>					
	<b>Vertical outlet Ø 100 - light grey</b>		<b>STCAN</b>		10
	<b>Vertical outlet Ø 110 - light grey</b>		<b>SVCAN</b>		10
	<b>Vertical outlet Ø 100 - black</b>		<b>STDR10</b>		10
	<b>Vertical outlet Ø 110 - black</b>		<b>SVDR10</b>		10
	<b>Sump unit</b>				
	outlet Ø 100		<b>PSCVT</b>		5
outlet Ø 110		<b>PSCVV</b>		5	

# Connecto® - Width 200 ext.

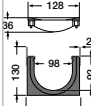
	DESCRIPTION	DRAWINGS	REF.	Packing	Packaging
<b>GALVANIZED STEEL CHANNEL</b>					
	Channel length 1m in PP with 1 galvanized steel mesh grating, locked on channel body		<b>CAN15BC</b>		Delivered only per pallets of 30 m and sold per elements of 1 m
	Pallet of 32 m (Delivery unit)		<b>PAN15BC</b>		
<b>DUCTILE IRON GRATING</b>					
	Channel length 1m in PP with 2 ductile iron slotted gratings, locked on channel body		<b>CAN15BF</b>		Delivered only per pallets of 30 m and sold per elements of 1 m
	Pallet of 30 m (Delivery unit)		<b>PAN15BF</b>		
	Set of screws to fix the gratings on CAN15BF (for 3 meters of channels) To be ordered by set of 12 pieces		<b>FIXCAN2N</b>	S12	
<b>ACCESSORIES</b>					
	<b>End cap/end or lateral outlet</b>				
	End cap/end or lateral outlet Ø 100		<b>NAT188</b>		10
	End cap/end or lateral outlet Ø 110		<b>NAV188</b>		10
	End cap/end or lateral outlet Ø 125		<b>NAX188</b>		10
	<b>Vertical outlet Ø 125</b>		<b>SXCAN</b>		10
	<b>Sump unit</b>				
	outlet Ø 100		<b>PSCVT</b>		5
	outlet Ø 110		<b>PSCVV</b>		5

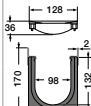

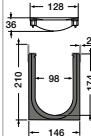

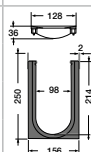

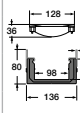

# HYDRAULIC DRAINAGE CHANNELS - B125

## Kenadrain® HD - Width 100 int.

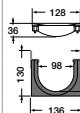
	DESCRIPTION	DRAWINGS	REF.	Packing	Packaging
<b>PVC GRATING</b>					
<b>PARK CHANNEL</b>					
<b>NEW GRATING !</b>	 <p><b>Channel length 1m with galvanized steel edges and 2 PVC slotted gratings - light grey</b> <b>Height 0 - 0,80 mm</b></p> <p>Locking: 1 screw per grating on galvanized locking bar</p>		<b>DR100BG</b>		Delivered per pallet of 40 m and sold per elements of 1 m
	<b>Pallet of 40 m</b> (Delivery unit)		<b>PR100BG</b>		
	<b>STEPPED-FALL CHANNEL</b>				
<b>NEW GRATING !</b>	 <p><b>Channel length 1m with galvanized steel edges and 2 PVC slotted gratings - light grey</b> <b>Height 1 - 130 mm</b></p> <p>Locking: 1 screw per grating on galvanized locking bar</p>		<b>DR101BG</b>		Delivered per pallet of 40 m and sold per elements of 1 m
	<b>Pallet of 40 m</b> (Delivery unit)		<b>PR101BG</b>		
	<b>NEW GRATING !</b>	 <p><b>Standard height</b></p> <p><b>Channel length 1m with galvanized steel edges and 2 PVC slotted gratings - light grey</b> <b>Height 2 - 170 mm</b></p> <p>Locking: 1 screw per grating on galvanized locking bar</p>		<b>DR102BG</b> <b>DR102BS</b>	
<b>Pallet of 40 m</b> (Delivery unit)			<b>PR102BG</b>		
<b>NEW GRATING !</b>		 <p><b>Channel length 1m with galvanized steel edges and 2 PVC slotted gratings - light grey</b> <b>Height 3 - 210 mm</b></p> <p>Locking: 1 screw per grating on galvanized locking bar</p>		<b>DR103BG</b>	
	<b>Pallet of 35 m</b> (Delivery unit)		<b>PR103BG</b>		
	<b>NEW GRATING !</b>	 <p><b>Channel length 1m with galvanized steel edges and 2 PVC slotted gratings - light grey</b> <b>Height 4 - 250 mm</b></p> <p>Locking: 1 screw per grating on galvanized locking bar</p>		<b>DR104BG</b>	
<b>Pallet of 28 m</b> (Delivery unit)			<b>PR104BG</b>		

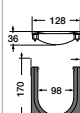
These channels could also be supplied with stainless steel edges.

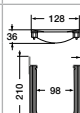

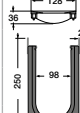





# Kenadrain® HD - Width 100 int.

	DESCRIPTION	DRAWINGS	REF.	Packing	Packaging
<b>PVC GRATING</b>					
<b>PARK CHANNEL</b>					
<b>NEW GRATING !</b>	 <p><b>Channel length 1m with galvanized steel edges and 2 PVC slotted gratings - sand</b> <b>Height 0 - 0,80 mm</b></p> <p>Locking: 1 screw per grating on galvanized locking bar</p>		<b>DR100BS</b>		Delivered per pallet of 40 m and sold per elements of 1 m
	<b>Pallet of 40 m</b> (Delivery unit)		<b>PR100BS</b>		
<b>STEPPED-FALL CHANNEL</b>					
<b>NEW GRATING !</b>	 <p><b>Channel length 1m with galvanized steel edges and 2 PVC slotted gratings - sand</b> <b>Height 1 - 130 mm</b></p> <p>Locking: 1 screw per grating on galvanized locking bar</p>		<b>DR101BS</b>		Delivered per pallet of 40 m and sold per elements of 1 m
	<b>Pallet of 40 m</b> (Delivery unit)		<b>PR101BS</b>		
<b>NEW GRATING !</b>	<p><b>Standard height</b></p>  <p><b>Channel length 1m with galvanized steel edges and 2 PVC slotted gratings - sand</b> <b>Height 2 - 170 mm</b></p> <p>Locking: 1 screw per grating on galvanized locking bar</p>		<b>DR102BS</b>		Delivered per pallet of 40 m and sold per elements of 1 m
	<b>Pallet of 40 m</b> (Delivery unit)		<b>PR102BS</b>		
<b>NEW GRATING !</b>	 <p><b>Channel length 1m with galvanized steel edges and 2 PVC slotted gratings - sand</b> <b>Height 3 - 210 mm</b></p> <p>Locking: 1 screw per grating on galvanized locking bar</p>		<b>DR103BS</b>		Delivered per pallet of 35 m and sold per elements of 1 m
	<b>Pallet of 35 m</b> (Delivery unit)		<b>PR103BS</b>		
<b>NEW GRATING !</b>	 <p><b>Channel length 1m with galvanized steel edges and 2 PVC slotted gratings - sand</b> <b>Height 4 - 250 mm</b></p> <p>Locking: 1 screw per grating on galvanized locking bar</p>		<b>DR104BS</b>		Delivered per pallet of 28 m and sold per elements of 1 m
	<b>Pallet of 28 m</b> (Delivery unit)		<b>PR104BS</b>		

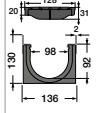

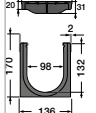

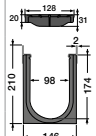

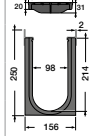

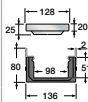

These channels could also be supplied with stainless steel edges.

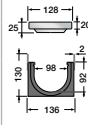
# HYDRAULIC DRAINAGE CHANNELS - B125

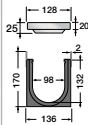
## Kenadrain® HD - Width 100 int.

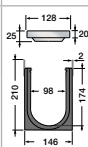
	DESCRIPTION	DRAWINGS	REF.	Packing	Packaging
<b>POLYAMIDE GRATING</b>					
<b>PARK CHANNEL</b>					
<b>NEW GRATING !</b>	 <p><b>Channel Length 1 m with galvanized steel edges and 2 polyamide gratings</b>  <b>Height 0 - 80 mm</b>                      Locking: 1 screw per grating on galvanized locking bar                      Stainless steel edges and locking device on request</p>		<b>DR100BN</b>		Delivered per pallet of 40 m and sold per elements of 1 m
	<b>Pallet of 40 m</b> (Delivery unit)		<b>PR100BN</b>		
<b>STEPPED-FALL CHANNEL</b>					
<b>NEW GRATING !</b>	 <p><b>Channel Length 1 m with galvanized steel edges and 2 polyamide gratings</b>  <b>Height 1 - 130 mm</b>                      Locking: 1 screw per grating on galvanized locking bar                      Stainless steel edges and locking device on request</p>		<b>DR101BN</b>		Delivered per pallet of 40 m and sold per elements of 1 m
	<b>Pallet of 40 m</b> (Delivery unit)		<b>PR101BN</b>		
<b>NEW GRATING !</b>	<div style="border: 1px solid red; padding: 2px; display: inline-block; color: white; font-weight: bold;">Standard height</div>  <p><b>Channel Length 1 m with galvanized steel edges and 2 polyamide gratings</b>  <b>Height 2 - 170 mm</b>                      Locking: 1 screw per grating on galvanized locking bar                      Stainless steel edges and locking device on request</p>		<b>DR102BN</b>		Delivered per pallet of 40 m and sold per elements of 1 m
	<b>Pallet of 40 m</b> (Delivery unit)		<b>PR102BN</b>		
<b>NEW GRATING !</b>	 <p><b>Channel Length 1 m with galvanized steel edges and 2 polyamide gratings</b>  <b>Height 3 - 210 mm</b>                      Locking: 1 screw per grating on galvanized locking bar                      Stainless steel edges and locking device on request</p>		<b>DR103BN</b>		Delivered per pallet of 35 m and sold per elements of 1 m
	<b>Pallet of 35 m</b> (Delivery unit)		<b>PR103BN</b>		
<b>NEW GRATING !</b>	 <p><b>Channel Length 1 m with galvanized steel edges and 2 polyamide gratings</b>  <b>Height 4 - 250 mm</b>                      Locking: 1 screw per grating on galvanized locking bar                      Stainless steel edges and locking device on request</p>		<b>DR104BN</b>		Delivered per pallet of 28 m and sold per elements of 1 m
	<b>Pallet of 28 m</b> (Delivery unit)		<b>PR104BN</b>		

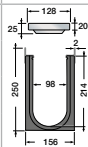
## Kenadrain® HD - Width 100 int.

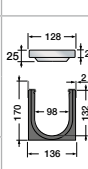
	DESCRIPTION	DRAWINGS	REF.	Packing	Packaging
<b>GALVANIZED STEEL GRATING</b>					
<b>PARK CHANNEL</b>					
	<b>Channel length 1 m with galvanized steel edges and 1 galvanized steel mesh grating</b> <b>Height 0 - 80 mm</b> Locking: 2 screws per grating on galvanized locking bar		<b>DR100BC</b>		Delivered per pallet of 40 m and sold per elements of 1 m
	<b>Pallet of 40 m</b> (Delivery unit)		<b>PR100BC</b>		
<b>STEPPED-FALL CHANNEL</b>					
	<b>Channel length 1 m with galvanized steel edges and 1 galvanized steel mesh grating</b> <b>Height 1 - 130 mm</b> Locking: 2 screws per grating on galvanized locking bar		<b>DR101BC</b>		Delivered per pallet of 40 m and sold per elements of 1 m
	<b>Pallet of 40 m</b> (Delivery unit)		<b>PR101BC</b>		
	<b>Channel length 1 m with galvanized steel edges and 1 galvanized steel mesh grating</b> <b>Height 2 - 170 mm</b> Locking: 2 screws per grating on galvanized locking bar		<b>DR102BC</b>		Delivered per pallet of 40m and sold per elements of 1m
	<b>Pallet of 40 m</b> (Delivery unit)		<b>PR102BC</b>		
	<b>Channel length 1 m with galvanized steel edges and 1 galvanized steel mesh grating</b> <b>Height 3 - 210 mm</b> Locking: 2 screws per grating on galvanized locking bar		<b>DR103BC</b>		Delivered per pallet of 35m and sold per elements of 1m
	<b>Pallet of 35 m</b> (Delivery unit)		<b>PR103BC</b>		
	<b>Channel length 1 m with galvanized steel edges and 1 galvanized steel mesh grating</b> <b>Height 4 - 250 mm</b> Locking: 2 screws per grating on galvanized locking bar		<b>DR104BC</b>		Delivered per pallet of 28 m and sold per elements of 1 m
	<b>Pallet of 28 m</b> (Delivery unit)		<b>PR104BC</b>		
<b>STAINLESS STEEL GRATING</b>					
	<b>Channel length 1 m with 1 stainless steel edges and stainless steel mesh grating</b> (for food industries) Locking: 2 screws per grating on stainless steel locking bar		<b>DR102BCI</b>		Delivered per pallet of 40 m and sold per elements of 1 m
	<b>Pallet of 40 m</b> (Delivery unit)		<b>PR102BCI</b>		

# HYDRAULIC DRAINAGE CHANNELS - B125

Kenadrain® HD - Width 100 int.

	DESCRIPTION	REF.	Packing	Packaging
<b>ACCESSORIES</b>				
	<b>End cap/end or lateral outlet</b>			
	Height 0 - Ø 50	<b>NJDR100</b>		10
	Height 1 - Ø 75	<b>NPDR101</b>		10
	Height 2 - Ø 100	<b>NTDR102</b>		10
	Height 2 - Ø 110	<b>NVDR102</b>		10
	Height 3 - Ø 100	<b>NTDR103</b>		10
	Height 3 - Ø 110	<b>NVDR103</b>		10
	Height 4 - Ø 100	<b>NTDR104</b>		10
	Height 4 - Ø 110	<b>NVDR104</b>		10
		<b>Outlet</b> (delivered with screws)		
Lateral or vertical Ø 100		<b>STDR10</b>		10
Lateral or vertical Ø 110		<b>SVDR10</b>		10
Lateral or vertical Ø 125		<b>SXDR10</b>		10
Lateral or vertical Ø 160		<b>SZDR20</b>		10
	<b>Step connector</b>	<b>SAB10</b>		
	<b>Adaptation part for sump PS100X, PS100V, STDR10, SVDR10 and SXDR10 at depths 3 and 4 of stepped-fall range</b>	<b>ADPS100</b>		
<b>SECURITY LOCKING SYSTEM</b>				
	<b>Set of 24 security bolts</b>	<b>VISDRI</b>	S1	
	<b>Security lock key</b>	<b>CLEDRI</b>	S1	
<b>SUMP</b>				
	<b>Ekso sump with lower outlet</b>			
	width 100 - outlet Ø 125	<b>PS100X</b>		4
	width 100 - outlet Ø 110	<b>PS100V</b>		4
	<b>Ekso sump with upper outlet</b>			
	width 100 - outlet Ø 125	<b>PS100XH</b>		
width 100 - outlet Ø 110	<b>PS100VH</b>			



# Kenadrain® HD - Width 150 int.

	HEIGHT	REF.	Packing	Packaging
<b>DUCTILE IRON GRATING</b>				
	<b>Channel length 1 m with galvanized steel edges and 2 ductile iron gratings</b> Locking: 2 screws per grating		<b>DR152BF</b>	Delivered per pallet of 30 m and sold per elements of 1 m
	<b>Pallet of 30 m</b> (Delivery unit)		<b>PR152BF</b>	
<b>GALVANIZED STEEL GRATING</b>				
	<b>Channel length 1 m with galvanized steel edge and 1 galvanized steel mesh gratings</b> Locking: 4 screws per grating		<b>DR152BC</b>	Delivered per pallet of 30 m and sold per elements of 1 m
	<b>Pallet of 30 m</b> (Delivery unit)		<b>PR152BC</b>	
<b>ACCESSORIES</b>				
 	<b>End cap/End outlet</b>			
	Ø 125		<b>NXDR152</b>	10
	<b>Lateral/vertical outlet</b> (delivered with screws)			
	Lateral Ø 125		<b>SXDR10</b>	10
	Vertical Ø 160		<b>SZDR20</b>	10
<b>SECURITY LOCKINGS SYSTEM</b>				
 	<b>Set of 24 security bolts</b>		<b>VISDRI</b>	S1
	<b>Security lock key</b>		<b>CLEDRI</b>	S1
<b>SUMP</b>				
 	<b>Ekso sump with lower outlet</b>			
	width 150 - outlet Ø 160		<b>PS150Z</b>	2
	<b>Ekso sump with upper outlet</b>			
	width 150 - outlet Ø 160		<b>PS150ZH</b>	

# HYDRAULIC DRAINAGE CHANNELS - B125

## Kenadrain® HD - Width 200 int.

	DESCRIPTION	DRAWINGS	REF.	Packing	Packaging
<b>GALVANIZED STEEL GRATING</b>					
	<b>Channel length 1 m with galvanized steel edges and 1 galvanized steel mesh gratings</b> Locking: 4 screws per grating		<b>DR202BC</b>		Delivered per pallet of 20 m and sold per elements of 1 m
	<b>Pallet of 20 m</b> (Delivery unit)		<b>PR202BC</b>		
<b>ACCESSORIES</b>					
	<b>End cap/end outlet</b> Ø 160		<b>NZDR202</b>		10
	<b>Lateral/vertical outlet</b> (delivered with screws) Lateral Ø 160		<b>SZDR20</b>		10
	Vertical Ø 200		<b>SBDR20</b>		10
<b>SECURITY LOCKING SYSTEM</b>					
	<b>Set of 24 security bolts</b>		<b>VISDRI</b>	S1	
	<b>Security lock key</b>		<b>CLEDRI</b>	S1	
<b>SUMP</b>					
	<b>Ekso sump with lower outlet</b> width 200 - outlet Ø 200		<b>PS200B</b>		2
	<b>Ekso sump with upper outlet</b> width 200 - outlet Ø 200		<b>PS200BH</b>		

# C250

## KERB SIDES AND HARD SHOULDERS



SANITARY

SANITARY

GLUE

RAINGUTTERS

ROOFING  
ACCESSORIES

FASCIA AND  
ROOFING SOFFIT  
BOARDS

BUILDING

ACCES  
TRAP DOOR

VENTILATION

SURFACE DRAINAGE  
PRODUCTS

HYDRAULIC  
DRAINAGE CHANNELS

ENVIRONMENT

HYDRAULIC  
DRAINAGE CHANNELS

SAUL







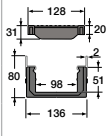

All our documents can be downloaded free of charge from: [www.nicoll.fr](http://www.nicoll.fr)

# HYDRAULIC DRAINAGE CHANNELS - C250

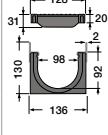
Connecto® - Width 130 ext.

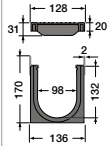
	DESCRIPTION	DRAWINGS	REF.	Packing	Packaging
<b>POLYAMIDE GRATING</b>					
	<b>Channel length 1 m in PP with stainless steel edges and 2 polyamide gratings</b> Locked: 2 screw per grating		<b>CAN10CN</b>		Delivered per pallet of 32 m and sold per elements of 1 m
	<b>Pallet of 32 m</b> (Delivery unit)		<b>PAN10CN</b>		
	Set of screws to fix the gratings CAB10ATI (for 6 meters of channels) <i>To be ordered by set of 12 pieces</i>		<b>FIXCAN3</b>	S2	
	<b>End cap/end outlet</b>				
	Ø 100		<b>NAT177N</b>		10
	Ø 110		<b>NAV177N</b>		10
<b>DUCTILE IRON GRATING</b>					
	<b>PP channel 1 m with 2 ductile iron gratings, locked on channel body</b>		<b>CAL10CF</b>		Delivered per pallet of 56 m and sold per elements of 1 m
	<b>Pallet of 56 m</b> (Delivery unit)		<b>PAL10CF</b>		
	<b>End cap/end outlet</b>				
	Ø 100		<b>NAT178</b>		10
	Ø 110		<b>NAV178</b>		10
<b>ACCESSORIES</b>					
	<b>Vertical outlet Ø 100 - black</b>		<b>STDR10</b>		10
	<b>Vertical outlet Ø 110 - black</b>		<b>SVDR10</b>		10
	<b>Sump unit</b>				
	outlet Ø 100		<b>PSCVT</b>		5
	outlet Ø 110		<b>PSCVV</b>		5

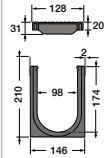

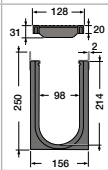



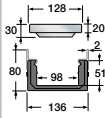

# Kenadrain® HD - Width 100 int.

	DESCRIPTION	DRAWINGS	REF.	Packing	Packaging
<b>POLYAMIDE GRATING</b>					
<b>PARK HD CHANNEL</b>					
<b>NEW GRATING !</b>	 <p><b>Channel length 1 m with galvanized steel edges and 2 polyamide gratings</b>  <b>Height 0 - 80 mm</b>                      Locking: 1 screw per grating on galvanized locking bar                      Stainless steel edges and locking device on request</p>		<b>DR100CN</b>		Delivered per pallet of 40 m and sold per elements of 1 m
	<b>Pallet of 40 m</b> (Delivery unit)		<b>PR100CN</b>		
<b>STEPPED-FALL HD CHANNEL</b>					
<b>NEW GRATING !</b>	 <p><b>Channel length 1 m with galvanized steel edges and 2 polyamide gratings</b>  <b>Height 1 - 130 mm</b>                      Locking: 1 screw per grating on galvanized locking bar                      Stainless steel edges and locking device on request</p>		<b>DR101CN</b>		Delivered per pallet of 40 m and sold per elements of 1 m
	<b>Pallet of 40 m</b> (Delivery unit)		<b>PR101CN</b>		
<b>NEW GRATING !</b>	<p>Standard height</p>  <p><b>Channel length 1 m with galvanized steel edges and 2 polyamide gratings</b>  <b>Height 2 - 170 mm</b>                      Locking: 1 screw per grating on galvanized locking bar                      Stainless steel edges and locking device on request</p>		<b>DR102CN</b>		Delivered per pallet of 40 m and sold per elements of 1 m
	<b>Pallet of 40 m</b> (Delivery unit)		<b>PR102CN</b>		
<b>NEW GRATING !</b>	 <p><b>Channel length 1 m with galvanized steel edges and 2 polyamide gratings</b>  <b>Height 3 - 210 mm</b>                      Locking: 1 screw per grating on galvanized locking bar                      Stainless steel edges and locking device on request</p>		<b>DR103CN</b>		Delivered per pallet of 35 m and sold per elements of 1 m
	<b>Pallet of 35 m</b> (Delivery unit)		<b>PR103CN</b>		
<b>NEW GRATING !</b>	 <p><b>Channel length 1 m with galvanized steel edges and 2 polyamide gratings</b>  <b>Height 4 - 250 mm</b>                      Locking: 1 screw per grating on galvanized locking bar                      Stainless steel edges and locking device on request</p>		<b>DR104CN</b>		Delivered per pallet of 28 m and sold per elements of 1 m
	<b>Pallet of 28 m</b> (Delivery unit)		<b>PR104CN</b>		

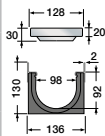
These channels could also be supplied with stainless steel edges.

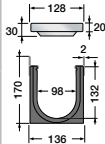

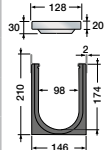

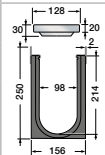

# HYDRAULIC DRAINAGE CHANNELS - C250

## Kenadrain® HD - Width 100 int.

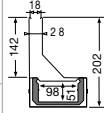
DESCRIPTION	DRAWINGS	REF.	Packing	Packaging
<b>GALVANIZED STEEL GRATING</b>				
<b>PARK HD CHANNEL</b>				
 <p><b>Channel length 1 m with galvanized steel edges and 1 galvanized steel mesh grating</b> <b>Height 0 - 80 mm</b> Locking: 2 screws per grating on galvanized locking bar</p>		<b>DR100CC</b>		Delivered per pallet of 40 m and sold per elements of 1 m
<b>STEPPED-FALL HD CHANNEL</b>				
 <p><b>Channel length 1 m with galvanized steel edges and 1 galvanized steel mesh grating</b> <b>Height 1 - 130 mm</b> Locking: 2 screws per grating on galvanized locking bar</p>		<b>DR101CC</b>		Delivered per pallet of 40 m and sold per elements of 1 m
<div style="background-color: red; color: white; padding: 2px; display: inline-block;">Standard height</div>  <p><b>Channel length 1 m with galvanized steel edges and 1 galvanized steel mesh grating</b> <b>Height 2 - 170 mm</b> Locking: 2 screws per grating on galvanized locking bar</p>		<b>DR102CC</b>		Delivered per pallet of 40 m and sold per elements of 1 m
 <p><b>Channel length 1 m with galvanized steel edges and 1 galvanized steel mesh grating</b> <b>Height 3 - 210 mm</b> Locking: 2 screws per grating on galvanized locking bar</p>		<b>DR103CC</b>		Delivered per pallet of 35 m and sold per elements of 1 m
 <p><b>Channel length 1 m with galvanized steel edges and 1 galvanized steel mesh grating</b> <b>Height 4 - 250 mm</b> Locking: 2 screws per grating on galvanized locking bar</p>		<b>DR104CC</b>		Delivered per pallet of 28 m and sold per elements of 1 m

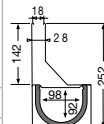

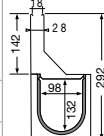

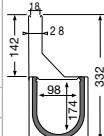
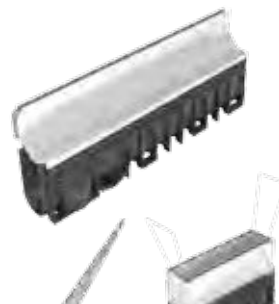
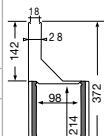

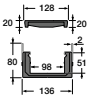

These channels could also be supplied with stainless steel edges.

# Kenadrain® HD - Width 100 int.

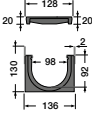
	DESCRIPTION	DRAWINGS	REF.	Packing	Packaging
<b>STAINLESS STEEL SLOT</b>					
<b>PARK HD CHANNEL</b>					
	Channel length 1 m with 304 stainless steel side slot (316 stainless steel on request)		DRI100CSE		
	Channel length 1 m with stainless steel side slot and anti-leaves 304 stainless steel grating (316 stainless steel on request)		DRIG100CSE		
	50 cm inspection box with stainless steel slot		RDRI100CS		
<b>STEPPED-FALL HD CHANNEL</b>					
	Channel length 1 m with 304 stainless steel side slot (316 stainless steel on request)		DRI101CSE		
	Channel length 1 m with stainless steel side slot and anti-leaves 304 stainless steel grating (316 stainless steel on request)		DRIG101CSE		
	50 cm inspection box with stainless steel slot		RDRI101CS		
Standard height		Channel length 1 m with 304 stainless steel side slot (316 stainless steel on request)		DRI102CSE	
Channel length 1 m with stainless steel side slot and anti-leaves 304 stainless steel grating (316 stainless steel on request)			DRIG102CSE		
50 cm inspection box with stainless steel slot			RDRI102CS		
	Channel length 1 m with 304 stainless steel side slot (316 stainless steel on request)		DRI103CSE		
	Channel length 1 m with stainless steel side slot and anti-leaves 304 stainless steel grating (316 stainless steel on request)		DRIG103CSE		
	50 cm inspection box with stainless steel slot		RDRI103CS		
	Channel length 1 m with 304 stainless steel side slot (316 stainless steel on request)		DRI104CSE		
	Channel length 1 m with stainless steel side slot and anti-leaves 304 stainless steel grating (316 stainless steel on request)		DRIG104CSE		
	50 cm inspection box with stainless steel slot		RDRI104CS		
	Galvanized steel available on request				

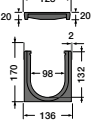
# HYDRAULIC DRAINAGE CHANNELS - C250

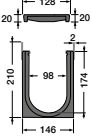

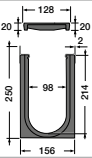



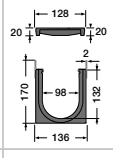

## Kenadrain® HD - Width 100 int.

	DESCRIPTION	DRAWINGS	REF.	Packing	Packaging
<b>HEEL DUCTILE IRON GRATING</b>					
<b>PARK HD CHANNEL</b>					
	<b>Channel length 1 m with galvanized steel edges and 2 ductile iron gratings - 6 mm slot width</b> <b>Height 0 - 80 mm</b> Locking: 1 screw per grating on galvanized locking bar		<b>DR100CH</b>		Delivered per pallet of 40 m and sold per elements of 1 m
	<b>Pallet of 40 m</b> (Delivery unit)		<b>PR100CH</b>		
<b>STEPPED-FALL HD CHANNEL</b>					
	<b>Channel length 1 m with galvanized steel edges and 2 ductile iron gratings - 6 mm slot width</b> <b>Height 1 - 130 mm</b> Locking: 1 screw per grating on galvanized locking bar		<b>DR101CH</b>		Delivered per pallet of 40 m and sold per elements of 1 m
	<b>Pallet of 40 m</b> (Delivery unit)		<b>PR101CH</b>		
	<b>Standard height</b> <b>Channel length 1 m with galvanized steel edges and 2 ductile iron gratings - 6 mm slot width</b> <b>Height 2 - 170 mm</b> Locking: 1 screw per grating on galvanized locking bar		<b>DR102CH</b>		Delivered per pallet of 40 m and sold per elements of 1 m
	<b>Pallet of 40 m</b> (Delivery unit)		<b>PR102CH</b>		
	<b>Channel length 1 m with galvanized steel edges and 2 ductile iron gratings - 6 mm slot width</b> <b>Height 3 - 210 mm</b> Locking: 1 screw per grating on galvanized locking bar		<b>DR103CH</b>		Delivered per pallet of 35 m and sold per elements of 1 m
	<b>Pallet of 35 m</b> (Delivery unit)		<b>PR103CH</b>		
	<b>Channel length 1 m with galvanized steel edges and 2 ductile iron gratings - 6 mm slot width</b> <b>Height 4 - 250 mm</b> Locking: 1 screw per grating on galvanized locking bar		<b>DR104CH</b>		Delivered per pallet of 28 m and sold per elements of 1 m
	<b>Pallet of 28 m</b> (Delivery unit)		<b>PR104CH</b>		

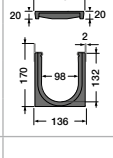
These channels could also be supplied with stainless steel edges.

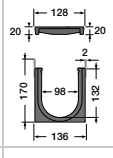

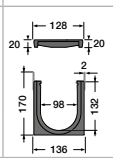
# Kenadrain® HD - Width 100 int.

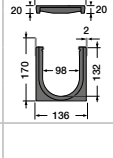
DESCRIPTION	DRAWINGS	REF.	Packing	Packaging
<b>HEEL DUCTILE IRON GRATING IN VARIOUS COLOURS</b>				
<b>COLOUR GRATING</b>				
 <p><b>Channel length 1 m with galvanized steel edges and 2 ductile iron gratings - 6 mm slot width</b> Red Laterite - Nearest RAL codes 8015 Locking: 1 screw per grating on galvanized locking bar</p>		<b>DR102CH8015</b>		Delivered per pallet of 40 m and sold per elements of 1 m
<b>Pallet of 40 m</b> (Delivery unit)		<b>PR102CH8015</b>		
 <p><b>Channel length 1 m with galvanized steel edges and 2 ductile iron gratings - 6 mm slot width</b> Yellow Pyrite - Nearest RAL codes 1015 Locking: 1 screw per grating on galvanized locking bar</p>		<b>DR102CH1015</b>		Delivered per pallet of 40 m and sold per elements of 1 m
<b>Pallet of 40 m</b> (Delivery unit)		<b>PR102CH1015</b>		
 <p><b>Channel length 1 m with galvanized steel edges and 2 ductile iron gratings - 6 mm slot width</b> Blue Basalt - Nearest RAL codes 5008 Locking: 1 screw per grating on galvanized locking bar</p>		<b>DR102CH5008</b>		Delivered per pallet of 40 m and sold per elements of 1 m
<b>Pallet of 40 m</b> (Delivery unit)		<b>PR102CH5008</b>		
 <p><b>Channel length 1 m with galvanized steel edges and 2 ductile iron gratings - 6 mm slot width</b> Grey Lunare - Nearest RAL codes 7046 Locking: 1 screw per grating on galvanized locking bar</p>		<b>DR102CH7046</b>		Delivered per pallet of 40 m and sold per elements of 1 m
<b>Pallet of 40 m</b> (Delivery unit)		<b>PR102CH7046</b>		
 <p><b>Channel length 1 m with galvanized steel edges and 2 ductile iron gratings - 6 mm slot width</b> Green Malachite - Nearest RAL codes 6028 Locking: 1 screw per grating on galvanized locking bar</p>		<b>DR102CH6028</b>		Delivered per pallet of 40 m and sold per elements of 1 m
<b>Pallet of 40 m</b> (Delivery unit)		<b>PR102CH6028</b>		

These channels could also be supplied with stainless steel edges.









Channels with Heel grating of colour are also available for PARK and STEPPED-FALL Channels.

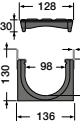

RAL 8015 RAL 1015 RAL 5008 RAL 7046 RAL 6028

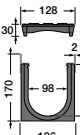
# HYDRAULIC DRAINAGE CHANNELS - C250

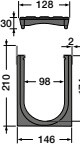
## Kenadrain® HD - Width 100 int.

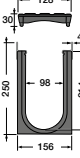
	DESCRIPTION	DRAWINGS	REF.	Packing	Packaging	
<b>DUCTILE IRON GRATING</b>						
<b>HD PARK CHANNEL</b>						
<b>NEW GRATING !</b>	 <p><b>Channel length 1 m with galvanized steel edges and 2 ductile iron gratings</b>  <b>Height 0 - 80 mm</b>                      Locking: 1 screw per grating on galvanized locking bar</p>		<b>DR100CF</b>		Delivered per pallet of 40 m and sold per elements of 1 m	
			<b>Pallet of 40 m</b> (Delivery unit)	<b>PR100CF</b>		
<b>STEPPED-FALL HD CHANNEL</b>						
<b>NEW GRATING !</b>	 <p><b>Channel length 1 m with galvanized steel edges and 2 ductile iron gratings</b>  <b>Height 1 - 130 mm</b>                      Locking: 1 screw per grating on galvanized locking bar</p>		<b>DR101CF</b>		Delivered per pallet of 40 m and sold per elements of 1 m	
			<b>Pallet of 40 m</b> (Delivery unit)	<b>PR101CF</b>		
<b>NEW GRATING !</b>	<div style="background-color: red; color: white; padding: 2px; display: inline-block;">Standard height</div>  <p><b>Channel length 1 m with galvanized steel edges and 2 ductile iron gratings</b>  <b>Height 2 - 170 mm</b>                      Locking: 1 screw per grating on galvanized locking bar</p>		<b>DR102CF</b>		Delivered per pallet of 40 m and sold per elements of 1 m	
			<b>Pallet of 40 m</b> (Delivery unit)	<b>PR102CF</b>		
<b>NEW GRATING !</b>	 <p><b>Channel length 1 m with galvanized steel edges and 2 ductile iron gratings</b>  <b>Height 3 - 210 mm</b>                      Locking: 1 screw per grating on galvanized locking bar</p>		<b>DR103CF</b>		Delivered per pallet of 35 m and sold per elements of 1 m	
			<b>Pallet of 35 m</b> (Delivery unit)	<b>PR103CF</b>		
<b>NEW GRATING !</b>	 <p><b>Channel length 1 m with galvanized steel edges and 2 ductile iron gratings</b>  <b>Height 4 - 250 mm</b>                      Locking: 1 screw per grating on galvanized locking bar</p>		<b>DR104CF</b>		Delivered per pallet of 28 m and sold per elements of 1 m	
			<b>Pallet of 28 m</b> (Delivery unit)	<b>PR104CF</b>		



These channels could also be supplied with stainless steel edges.

# Kenadrain® HD - Width 100 int.

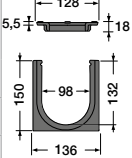

	DESCRIPTION	REF.	Packing	PACKAGING
<b>ACCESSORIES</b>				
	<b>End cap/end outlet</b>			
	Height 0 - Ø 50	<b>NJDR100</b>		10
	Height 1 - Ø 75	<b>NPDR101</b>		10
	Height 2 - Ø 100	<b>NTDR102</b>		10
	Height 2 - Ø 110	<b>NVDR102</b>		10
	Height 3 - Ø 100	<b>NTDR103</b>		10
	Height 3 - Ø 110	<b>NVDR103</b>		10
	Height 4 - Ø 100	<b>NTDR104</b>		10
	Height 4 - Ø 110	<b>NVDR104</b>		10
		<b>Lateral/vertical outlet</b> (delivered with screws)		
Lateral or vertical Ø 100		<b>STDR10</b>		10
Lateral or vertical Ø 110		<b>SVDR10</b>		10
Lateral or vertical Ø 125		<b>SXDR10</b>		10
Lateral or vertical Ø 160		<b>SZDR20</b>		10
	<b>Step connector</b>	<b>SAB10</b>		
	<b>Adaptation part for Sump PS100X, PS100V, STDR10, SVDR10 and SXDR10 for depths 3 and 4 of stepped-fall range</b>	<b>ADPS100</b>		
<b>SECURITY LOCKING SYSTEM</b>				
	<b>Set of 24 security bolts</b>	<b>VISDRI</b>	S1	
	<b>Security lock key</b>	<b>CLEDRI</b>	S1	
<b>SAND BOX</b>				
	<b>50cm sand box, width 100 with galvanized steel edge with 1 ductile iron grating</b> - Sand boxes are available with all gratings of the range in width 100.	<b>BS102CF</b>		8
<b>SUMP</b>				
	<b>Ekso sump with lower outlet</b>			
	width 100 - outlet Ø 125	<b>PS100X</b>		4
	width 100 - outlet Ø 110	<b>PS100V</b>		4
	<b>Ekso sump with upper outlet</b>			
	width 100 - outlet Ø 125	<b>PS100XH</b>		
width 100 - outlet Ø 110	<b>PS100VH</b>			

# HYDRAULIC DRAINAGE CHANNELS - C250

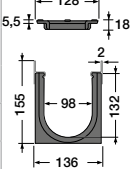
## Kenadrain® MD range - Width 100

		HEIGHT	REF.	Packing	Packaging
<b>CLASS C250</b>					
	<b>Channel length 1 m without galvanized steel edges and with 2 overlaying ductile iron gratings</b> Locking: 2 screws per grating		<b>DL102CF</b>		Delivered per pallet of 40 m and sold per elements of 1 m
	<b>Pallet of 40 m</b> (Delivery unit)		<b>PL102CF</b>		
	<b>Channel length 1 m with low galvanized steel edges and 2 ductile iron gratings</b> Locking: 1 screw per grating on galvanized locking bar		<b>DM102CF</b>		Delivered per pallet of 40 m and sold per elements of 1 m
	<b>Pallet of 40 m</b> (Delivery unit)		<b>PM102CF</b>		

## Kenadrain® MD accessories

		REF.	Packing	Packaging
<b>WIDTH 100</b>				
	<b>End cap/end outlet</b>			
	Ø 100	<b>NTDL102</b>		10
	Ø 110	<b>NVDL102</b>		10
	<b>Lateral/vertical outlet</b> (delivered with screws)			
	Lateral or vertical Ø 100	<b>STDR10</b>		10
	Lateral or vertical Ø 110	<b>SVDR10</b>		10
	Lateral or vertical Ø 125	<b>SXDR10</b>		10

# Kenadrain® HD - Width 150 int.

NEW GRATING !

	DESCRIPTION	DRAWINGS	REF.	Packing	Packaging
<b>DUCTILE IRON GRATING</b>					
	<b>Channel length 1 m with galvanized steel edges and 2 ductile iron gratings</b> Locking: 4 screws per grating		<b>DR152CF</b>		Delivered per pallet of 30 m and sold per elements of 1 m
	<b>Pallet of 30 m</b> (Delivery unit)		<b>PR152CF</b>		
<b>STAINLESS STEEL SLOT</b>					
 	<b>Channel length 1 m with 304 stainless steel side slot</b> (316 stainless steel on request)		<b>DRI152CSE</b>		
	<b>Channel Length 1 m with 304 stainless steel anti-leaves grating</b> (316 stainless steel on request)		<b>DRIG152CSE</b>		
	<b>50 cm Inspection box stainless steel with slot</b> (316 stainless steel on request)		<b>RDRI152CS</b>		
<b>ACCESSORIES</b>					
 	<b>End cap/end outlet</b> Ø 125		<b>NXDR152</b>		10
	<b>Lateral/vertical outlet</b> (delivered with screws) Lateral Ø 125		<b>SXDR10</b>		10
	Vertical Ø 160		<b>SZDR20</b>		10
<b>SECURITY LOCKING SYSTEM</b>					
 	<b>Set of 24 security bolts</b>		<b>VISDRI</b>	S1	
	<b>Security lock key</b>		<b>CLEDRI</b>	S1	
<b>SUMP</b>					
 	<b>Ekso sump with lower outlet</b> width 150 - outlet Ø 160		<b>PS150Z</b>		2
	<b>Ekso sump with upper outlet</b> width 150 - outlet Ø 160		<b>PS150ZH</b>		

# HYDRAULIC DRAINAGE CHANNELS - C250

## Kenadrain® HD - Width 200 int.

	DESCRIPTION	DRAWINGS	REF.	Packing	Packaging
<b>DUCTILE IRON GRATING</b>					
<b>NEW GRATING !</b>	 <p><b>Channel length 1 m with galvanized steel edges and 2 ductile iron gratings</b> Locking: 4 screws per grating</p>		<b>DR202CF</b>		Delivered per pallet of 20 m and sold per elements of 1 m
	<b>Pallet of 20 m</b> (Delivery unit)		<b>PR202CF</b>		
<b>ACCESSORIES</b>					
 	<b>End cap/end outlet</b> Ø 160		<b>NZDR202</b>		10
	<b>Lateral/vertical outlet</b> (delivered with screws)				
	Lateral Ø 160		<b>SZDR20</b>		10
	Vertical Ø 200		<b>SBDR20</b>		10
<b>SECURITY LOCKING SYSTEM</b>					
 	<b>Set of 24 security bolts</b>		<b>VISDRI</b>	S1	
	<b>Security lock key</b>		<b>CLEDRI</b>	S1	
<b>SUMP</b>					
 	<b>Ekso sump with lower outlet</b> width 200 - outlet Ø 200		<b>PS200B</b>		2
	<b>Ekso sump with upper outlet</b> width 200 - outlet Ø 200		<b>PS200BH</b>		

# Kenadrain® HD - Width 300 int.

NEW GRATING !



**Channel length 1 m with galvanized steel edges and 2 ductile iron gratings**

Locking: 4 screws per grating

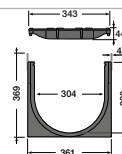

**DR302CF**

Delivered per pallet of 9 m and sold per elements of 1 m

**Pallet of 9 m (Delivery unit)**

**PR302CF**

## ACCESSORIES



**End cap/end outlet**

Ø 250

**NDDR302**



**Lateral/vertical outlet (delivered with screws)**

Lateral Ø 200

**SBDR20**

10

Vertical Ø 315

**SEDR30**

10

## SECURITY LOCKING SYSTEM



**Set of 24 security bolts**

**VISDRI**

S1

**Security lock key**

**CLEDRI**

S1

## SUMP



**Ekso sump with lower outlet**

width 300 - outlet Ø 315

**PS300E**

**Sump Ekso with upper outlet**

width 300 - outlet Ø 315

**PS300EH**

SANITARY

DRAINAGE FITTINGS

SANITARY

GLUE

RAINGUTTERS

ROOFING ACCESSORIES

FASCIA AND ROOFING SOFFIT BOARDS

BUILDING

ACCES TRAP DOOR

VENTILATION

SURFACE DRAINAGE PRODUCTS

HYDRAULIC DRAINAGE CHANNELS

ENVIRONMENT

HYDRAULIC DRAINAGE CHANNELS

SAUL

# D400 TRAFFIC AREAS FOR ROAD VEHICLES

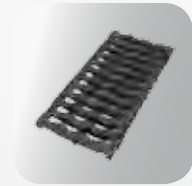
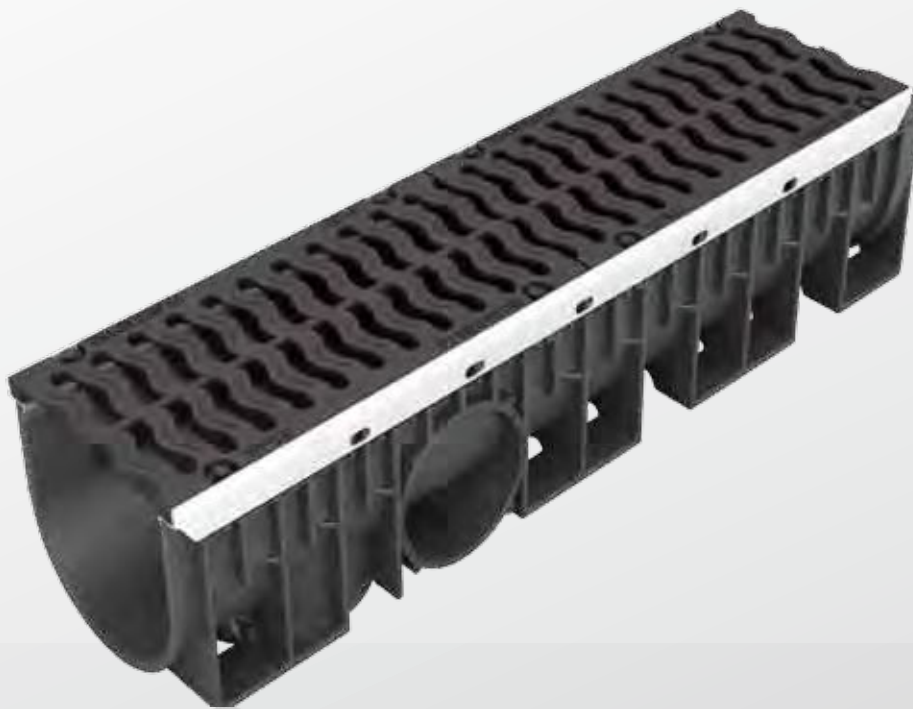







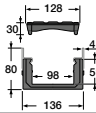

All our documents can be downloaded free of charge from: [www.nicoll.fr](http://www.nicoll.fr)

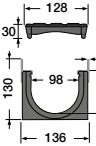

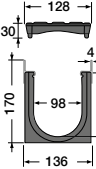
# HYDRAULIC DRAINAGE CHANNELS - D400

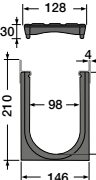
## Kenadrain® HD - Width 100 int.

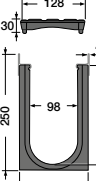
	DESCRIPTION	DRAWINGS	REF.	Packing	Packaging
<b>DUCTILE IRON GRATING</b>					
<b>PARK HD CHANNEL</b>					
<b>NEW GRATING !</b>	 <p><b>Channel length 1 m galvanized steel edges with 2 ductile iron grating</b>  <b>Height 0 - 80 mm</b>                      Locking: 1 screw per grating on galvanized locking bar</p>		<b>DR100DF</b>		Delivered per pallet of 40 m and sold per elements of 1 m
	<b>Pallet of 40 m</b> (Delivery unit)		<b>PR100DF</b>		
<b>STEPPED-FALL HD CHANNEL</b>					
<b>NEW GRATING !</b>	 <p><b>Channel length 1 m with galvanized steel edges and 2 ductile iron gratings</b>  <b>Height 1 - 130 mm</b>                      Locking: 1 screw per grating on galvanized locking bar</p>		<b>DR101DF</b>		Delivered per pallet of 40 m and sold per elements of 1 m
	<b>Pallet of 40 m</b> (Delivery unit)		<b>PR101DF</b>		
<b>NEW GRATING !</b>	<div style="border: 1px solid red; padding: 2px; display: inline-block; color: white; font-weight: bold;">Standard height</div>  <p><b>Channel length 1 m with galvanized steel edges and 2 ductile iron gratings</b>  <b>Height 2 - 170 mm</b>                      Locking: 1 screw per grating on galvanized locking bar</p>		<b>DR102DF</b>		Delivered per pallet of 40 m and sold per elements of 1 m
	<b>Pallet of 40 m</b> (Delivery unit)		<b>PR102DF</b>		
<b>NEW GRATING !</b>	 <p><b>Channel length 1 m with galvanized steel edges and 2 ductile iron gratings</b>  <b>Height 3 - 210 mm</b>                      Locking: 1 screw per grating on galvanized locking bar</p>		<b>DR103DF</b>		Delivered per pallet of 35 m and sold per elements of 1 m
	<b>Pallet of 35 m</b> (Delivery unit)		<b>PR103DF</b>		
<b>NEW GRATING !</b>	 <p><b>Channel length 1 m with galvanized steel edges and 2 ductile iron gratings</b>  <b>Height 4 - 250 mm</b>                      Locking: 1 screw per grating on galvanized locking bar</p>		<b>DR104DF</b>		Delivered per pallet of 28 m and sold per elements of 1 m
	<b>Pallet of 28 m</b> (Delivery unit)		<b>PR104DF</b>		

# Kenadrain® HD - Width 100 int.

	DESCRIPTION	REF.	Packing	Packaging
<b>ACCESSORIES</b>				
	<b>End cap/end outlet</b>			
	Height 0 - Ø 50	<b>NJDR100</b>		10
	Height 1 - Ø 75	<b>NPDR101</b>		10
	Height 2 - Ø 100	<b>NTDR102</b>		10
	Height 2 - Ø 110	<b>NVDR102</b>		10
	Height 3 - Ø 100	<b>NTDR103</b>		10
	Height 3 - Ø 110	<b>NVDR103</b>		10
	Height 4 - Ø 100	<b>NTDR104</b>		10
	Height 4 - Ø 110	<b>NVDR104</b>		10
	<b>Lateral/vertical outlet</b> (delivered with screws)			
	Lateral or vertical Ø 100	<b>STDR10</b>		10
	Lateral or vertical Ø 110	<b>SVDR10</b>		10
	Lateral or vertical Ø 125	<b>SXDR10</b>		10
	Lateral or vertical Ø 160	<b>SZDR20</b>		10
	<b>Step connector</b>	<b>SAB10</b>		
	<b>Adaptation part for sump PS100X, PS100V, STDR10, SVDR10 and SXDR10 for depths 3 and 4 of stepped-fall range</b>	<b>ADPS100</b>		
<b>SECURITY LOCKING SYSTEM</b>				
	<b>Set of 24 security bolts</b>	<b>VISDRI</b>	S1	
	<b>Security lock key</b>	<b>CLEDRI</b>	S1	
<b>SUMP</b>				
	<b>Ekso sump with lower outlet</b>			
	width 100 - outlet Ø 125	<b>PS100X</b>		4
	width 100 - outlet Ø 110	<b>PS100V</b>		4
	<b>Ekso sump with upper outlet</b>			
	width 100 - outlet Ø 125	<b>PS100X</b>		
	width 100 - outlet Ø 110	<b>PS100V</b>		

# HYDRAULIC DRAINAGE CHANNELS - D400

## Kenadrain® HD - Width 150 int.

NEW GRATING !



DESCRIPTION	DRAWINGS	REF.	Packing	Packaging
-------------	----------	------	---------	-----------

### DUCTILE IRON GRATING

**Channel length 1 m with galvanized steel edges and 2 ductile iron gratings**  
 Locking: 4 screws per grating

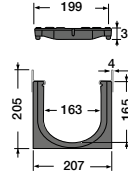

**DR152DF**

Delivered per pallet of 30 m and sold per elements of 1 m

**Pallet of 30 m** (Delivery unit)

**PR152DF**

### ACCESSORIES



**End cap/end outlet**

Ø 125

**NXDR152**

10



**Lateral/vertical outlet** (delivered with screws)

Lateral Ø 125

**SXDR10**

10

Vertical Ø 160

**SZDR20**

10

### SECURITY LOCKING SYSTEM



**Set of 24 security bolts**

**VISDRI**

S1

**Security lock key**

**CLEDRI**

S1

### SUMP



**Ekso sump with lower outlet**

width 150 - outlet Ø 160

**PS150Z**

2

**Ekso sump with upper outlet**

width 150 - outlet Ø 160

**PS150ZH**

# Kenadrain® HD - Width 200 int.

NEW GRATING !



**Channel length 1 m with galvanized steel edges and 2 ductile iron gratings**  
Locking: 4 screws per grating

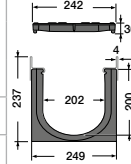

**DR202DF**

Delivered per pallet of 20 m and sold per elements of 1 m

**Pallet of 20 m** (Delivery unit)

**PR202DF**

## ACCESSORIES



**End cap/end outlet**

Ø 160

**NZDR202**

10



**Lateral/vertical outlet** (delivered with screws)

Lateral Ø 160

**SZDR20**

10

Vertical Ø 200

**SBDR20**

10

## SECURITY LOCKING SYSTEM



**Set of 24 security bolts**

**VISDRI**

S1



**Security lock key**

**CLEDRI**

S1

## SUMP



**Ekso sump with lower outlet**

width 200 - outlet Ø 200

**PS200B**

2

**Ekso sump with upper outlet**

width 200 - outlet Ø 200

**PS200BH**

# Kenadrain® projects - Drain Channel

## Environment

NEW



The range of Kenadrain® drainage channels is intended to the market of petrol stations. It meets the challenges of shifting/braking and recurrent passing of cars thanks to its robustness and durability foolproof.

### Advantages :

- Light-weight
- Gratings locked on the channel body with assembled gratings
- Quick installation
- Spigot/socket interlocking joint system
- Easy connection to the drainage-pipe work
- Optimum hydraulic performance
- 100 % recycled materials
- Without corrosion



# HYDRAULIC DRAINAGE CHANNELS - D400

## Kenadrain® HD - Width 300 int.

NEW GRATING !



DESCRIPTION	DRAWINGS	REF.	Packing	Packaging
<b>DUCTILE IRON GRATING</b>				
<b>Channel length 1 m with galvanized steel edges and 2 ductile iron gratings</b> Locking: 4 screws per grating		<b>DR302DF</b>	Delivered per pallet of 9 m and sold per elements of 1m	
<b>Pallet of 9 m</b> (Delivery unit)		<b>PR302DF</b>		

### ACCESSORIES



<b>End cap/end outlet</b> Ø 250		<b>NDDR302</b>		
<b>Lateral/vertical outlet</b> (delivered with screws) Lateral Ø 200 Vertical Ø 315		<b>SBDR20</b> <b>SEDR30</b>		10

### SECURITY LOCKING SYSTEM



<b>Set of 24 security bolts</b>		<b>VISDRI</b>	S1	
<b>Security lock key</b>		<b>CLEDRI</b>	S1	

### SUMP



<b>Ekso sump with lower outlet</b> width 300 - outlet Ø 315		<b>PS300E</b>		
<b>Ekso sump with upper outlet</b> width 300 - outlet Ø 315		<b>PS300EH</b>		

SANITARY

DRAINAGE FITTINGS

SANITARY

GLUE

RAINGUTTERS

ROOFING ACCESSORIES

FASCIA AND ROOFING SOFFIT BOARDS

BUILDING

ACCES TRAP DOOR

VENTILATION

SURFACE DRAINAGE PRODUCTS

HYDRAULIC DRAINAGE CHANNELS

ENVIRONMENT

HYDRAULIC DRAINAGE CHANNELS

SAUL

**E600**  
**TRAFFIC AREAS SUBJECT TO**  
**HIGH WHEEL LOADS**

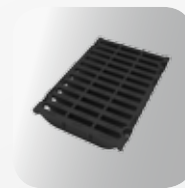

All our documents can be downloaded free of charge from: [www.nicoll.fr](http://www.nicoll.fr)

# New range of drainage channels Kenadrain® E600

Environment

NEW



The new range of drainage channels Kenadrain® is designed for areas subject to significant axle loads (E600 load rating) enabling use of the width from 100 to 300.

## Advantages :

- Robust : complies with NF EN 1433
- Efficient : excellent hydraulic capacity
- Practical : interlocked, supplied already fitted to the drainage channel
- Safe : complies with accessibility requirements for people with reduced mobility, high mechanical strength, slip-resistant
- Durable : resistant to the main chemical agents
- Aesthetic and functional : an innovative design in a black matt colour





# HYDRAULIC DRAINAGE CHANNELS - E600

## Kenadrain® HD - Width 100 int.

NEW !



**Channel length 1 m with galvanized steel edges and 2 ductile iron gratings**  
**Height 2 - 170 mm**  
 Locking: 1 screw per grating on galvanized locking bar

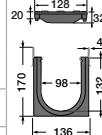

**DR102EF**

Delivered per pallet of 40 m and sold per elements of 1 m

**Pallet of 40 m** (Delivery unit)

**PFR102EF**

**Channels classed E600 are available in fumigated pallets only.**

### DUCTILE IRON GRATING

### ACCESSORIES

#### End cap/end outlet

Height 0 - Ø 50

**NJDR100**

10

Height 1 - Ø 75

**NPDR101**

10

Height 2 - Ø 100

**NTDR102**

10

Height 2 - Ø 110

**NVDR102**

10

Height 3 - Ø 100

**NTDR103**

10

Height 3 - Ø 110

**NVDR103**

10

Height 4 - Ø 100

**NTDR104**

10

Height 4 - Ø 110

**NVDR104**

10

#### Lateral/vertical outlet (delivered with screws)

Lateral or vertical Ø 100

**STDR10**

10

Lateral or vertical Ø 110

**SVDR10**

10

Lateral or vertical Ø 125

**SXDR10**

10

Lateral or vertical Ø 160

**SZDR20**

10

#### Step connector

**SAB10**

**Adaptation part for sump PS100X, PS100V, STDR10, SVDR10 and SXDR10 for depths 3 and 4 of stepped-fall range**

**ADPS100**

### SECURITY LOCKING SYSTEM

**Set of 24 security bolts**

**VISDRI**

S1

**Security lock key**

**CLEDRI**

S1

### SUMP

#### Ekso sump with lower outlet

width 100 - outlet Ø 125

**PS100X**

4

width 100 - outlet Ø 110

**PS100V**

4

#### Ekso sump with upper outlet

width 100 - outlet Ø 125

**PS100XH**

width 100 - outlet Ø 110

**PS100VH**



SANITARY

SANITARY

GLUE

RAINGUTTERS

ROOFING ACCESSORIES

FASCIA AND ROOFING SOFFIT BOARDS

BUILDING

ACCES TRAP DOOR

VENTILATION

SURFACE DRAINAGE PRODUCTS

HYDRAULIC DRAINAGE CHANNELS

HYDRAULIC DRAINAGE CHANNELS

ENVIRONMENT

SAUL

# HYDRAULIC DRAINAGE CHANNELS - E600

## Kenadrain® HD - Width 150 int.

NEW !

	DESCRIPTION	DRAWINGS	REF.	Packing	Packaging
<b>DUCTILE IRON GRATING</b>					
	<b>Channel length 1 m with galvanized steel edges and 2 ductile iron gratings</b> Locking: 4 screws per grating		<b>DR152EF</b>		Delivered per pallet of 30 m and sold per elements of 1 m
	<b>Pallet of 30 m</b> (Delivery unit)		<b>PFR152EF</b>		
<b>Channels classed E600 are available in fumigated pallets only.</b>					
<b>ACCESSORIES</b>					
	<b>End cap/end outlet</b> Ø 125		<b>NXDR152</b>		10
	<b>Lateral/vertical outlet</b> (delivered with screws) Lateral Ø 125		<b>SXDR10</b>		10
	Vertical Ø 160		<b>SZDR20</b>		10
<b>SECURITY LOCKING SYSTEM</b>					
	<b>Set of 24 security bolts</b>		<b>VISDRI</b>	S1	
	<b>Security lock key</b>		<b>CLEDRI</b>	S1	
<b>SUMP</b>					
	<b>Ekso sump with lower outlet</b> width 150 - outlet Ø 160		<b>PS150Z</b>		2
	<b>Ekso sump with upper outlet</b> width 150 - outlet Ø 160		<b>PS150ZH</b>		

# Kenadrain® HD - Width 200 int.

	DESCRIPTION	DRAWINGS	REF.	Packing	Packaging
<b>DUCTILE IRON GRATING</b>					
<b>NEW !</b> 	<b>Channel length 1 m with galvanized steel edges and 2 ductile iron gratings</b> Locking: 4 screws per grating		<b>DR202EF</b>		Delivered per pallet of 20 m and sold per elements of 1 m
	<b>Pallet of 20 m</b> (Delivery unit)		<b>PFR202EF</b>		
<b>Channels classed E600 are available in fumigated pallets only.</b>					
<b>ACCESSORIES</b>					
	<b>End cap/end outlet</b> Ø 160		<b>NZDR202</b>		10
		<b>Lateral/vertical outlet</b> (delivered with screws) Lateral Ø 160 Vertical Ø 200		<b>SZDR20</b> <b>SBDR20</b>	
<b>SECURITY LOCKING SYSTEM</b>					
	<b>Set of 24 security bolts</b>		<b>VISDRI</b>	S1	
	<b>Security lock key</b>		<b>CLEDRI</b>	S1	
<b>SUMP</b>					
	<b>Ekso sump with lower outlet</b> width 200 - outlet Ø 200		<b>PS200B</b>		2
	<b>Ekso sump with upper outlet</b> width 200 - outlet Ø 200		<b>PS200BH</b>		

# HYDRAULIC DRAINAGE CHANNELS

## Kenadrain® HD - Width 300 int.

NEW !



**Channel length 1 m with galvanized steel edges and 2 ductile iron gratings**

Locking: 4 screws per grating

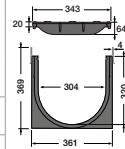

**DR302EF**

**Pallet of 9 m** (Delivery unit)

**PFR302EF**

Delivered per pallet of 9 m and sold per elements of 1 m

Channels classed E600 are available in fumigated pallets only.

### ACCESSORIES



**End cap/end outlet**

Ø 250

**NDDR302**

**Lateral/vertical outlet** (delivered with screws)

Lateral Ø 200

**SBDR20**

10

Vertical Ø 315

**SEDR30**

### SECURITY LOCKING SYSTEM



**Set of 24 security bolts**

**VISDRI**

S1

**Security lock key**

**CLEDRI**

S1

### SUMP



**Ekso sump with lower outlet**

width 300 - outlet Ø 315

**PS300E**

**Ekso sump with upper outlet**

width 300 - outlet Ø 315

**PS300EH**

## FLOOR DRAINS AND SHOWER CHANNELS

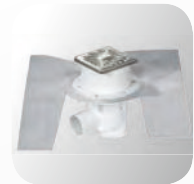
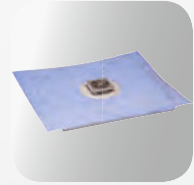

All our documents can be downloaded free of charge from: [www.nicoll.fr](http://www.nicoll.fr)

# THE RANGE OF WALK-IN SHOWER DRAINAGE SYSTEMS

Nicoll knows that every project is different and that the method of installation will vary. We can offer you an appropriate solution for your project: shower channels, ready-to-tile shower boards, floor drains for tiled or vinyl floors.

SHOWER DRAINAGE SYSTEM	THE TECHNICAL CONSTRAINTS OF YOUR PROJECT							
	PRODUCT IMAGE	FLOW RATE	SPACE REQUIRED	SEALING SYSTEM	TYPE OF CONNECTION	DIAMETER OF CONNECTION	EASE OF INSTALLATION	PRICE
Shower channel (width 50 mm)				On screed	Horizontal	Ø 40 mm	+++	€ € €
Low-height channel				On screed	Horizontal	Ø 40 mm	+++	€ € €
Stainless steel shower channel (width 70 mm)				On screed	Horizontal	Ø 40/50 mm	+++	€ € €
Floorline shower channel				On screed	Horizontal	Ø 40/50 mm	++	€ €
Stainless steel shower channel with ready-to-tile shower board (width 70 mm)				On shower board	Horizontal	Ø 40/50 mm	++	€ € €
Turbosol floor drains with ready-to-tile shower board				On shower board	Horizontal or vertical	Ø 40/50 mm	++	€ € €
SICA floor drains with ready-to-tile shower board				On shower board	Horizontal or vertical	Ø 50 mm or Ø 50/63mm	++	€ € €
SICA floor drains for tiled flooring				On and under screed	Horizontal or vertical	Ø 50 mm or Ø 50/63mm	+++	€ €
Turbosol floor drains with PVC film				Under screed	Horizontal	Ø 40/50 mm	++	€ €
Shower corner drain				On screed	Horizontal	Ø 40 mm	+++	€ €
Floor drains Floor line				On and under screed	Horizontal or vertical	Ø 40/50 mm	+++	€ €
SITAR floor drains for vinyl floors				On screed	Horizontal or vertical	Ø 50 mm or Ø 50/63mm	+++	€ €
Shallow trapped channels with floor gully				Without	Vertical	Ø 40/50 mm or Ø 93mm	+++	€
Floor drains				Without	Horizontal (with adaptor) or vertical	Ø 50/40 mm or Ø 50/40/93 mm	++++	€



**YOUR TYPE OF APPLICATION**

TILED FLOOR				PVC FLOOR			Pages
INDIVIDUAL SHOWERS	HOTELS SPAS	COMMUNAL SHOWERS	UTILITY AREAS	HOSPITALS	CLINICS	RETIREMENT HOMES	
							p.84
							p.84
							p.86
							p.88
							p.90
							p.91
							p.93
							p.95
							P.97
							p.96
							p.97
							p.98
							p.89
							p.99



## SHOWER CHANNELS

### DOCIA® CHANNELS: THE AESTHETIC SOLUTION FOR WALK-IN SHOWERS

The DOCIA® range offers a multitude of innovative, reliable aesthetic solutions to meet the style and technical requirements of all your bathroom projects.

#### CHANNELS WITH 50 MM WIDE GRATINGS

- channel lengths available (40-70-80-90-100 cm)
- 7 models of gratings

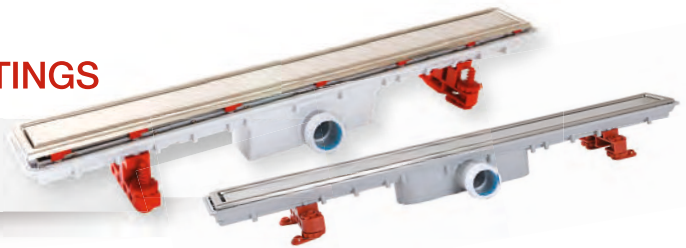

#### STAINLESS STEEL CHANNEL BODIES WITH 70 MM WIDE GRATING

- 5 channel lengths available (70-80-90-100-120 cm)
- 8 models of grating



#### TO BE FIXED TO THE WALL WITHOUT UNSIGHTLY CUTTING:

- reduced-width plate
- adjustable feet

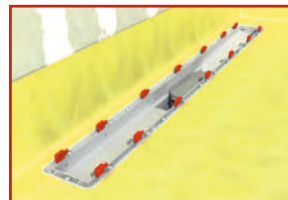

#### POSITION HEIGHT ADJUSTMENT (6/8/10/12/16 mm):

- from mosaics to large tiles.



#### NO COMPROMISE ON SEAL PERFORMANCE:

- reliability of the solvent welding in concrete
- clamping flange for the sealing membrane.



#### HIGH DRAINAGE FLOW RATE:

- 0,44 l/sec for the low height channel
- 0,66 l/sec for the original channel

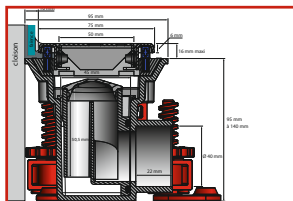

#### ODOUR TIGHTNESS SYSTEM:

- 50 mm water seal for the original channel
- 30 mm water seal + odour tightness system for the low-height channel



#### HYGIENIC AND EASY TO CLEAN:

- built-in slope to prevent stagnant water formation
- trap can be extracted for cleaning.



# LOW-HEIGHT SHOWER CHANNEL LENGTH 40 CM / DRAIN FOR CORNER

Sanitary

NEW



**Nicoll** innovates and increases its range of floor drains and channels for walk-in shower drainage systems with new technical and aesthetic solutions.

## LOW HEIGHT SHOWER CHANNEL:

- ▶ Only 69 mm high
- ▶ System anti-ascent of smells: 30 mm water seal with anti-desiphonnage trap
- ▶ Flow of 0,44L/s

## CHANNEL 40 cm LENGTH:

- ▶ Design solution

## DRAIN FOR CORNER :

- ▶ Discreet and original solution with a drainage in corner
- ▶ Wall fixation

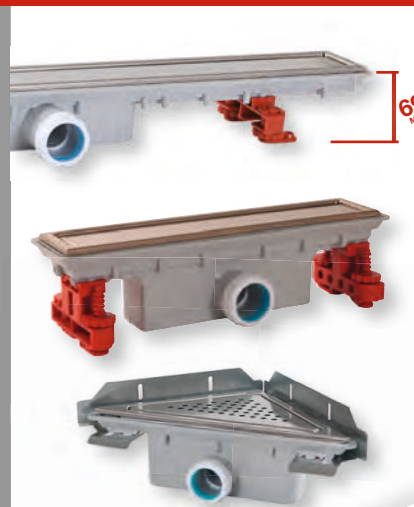

SANITARY

SANITARY

GLUE

RAINGUTTERS

ROOFING  
ACCESSORIES

FASCIA AND  
ROOFING SOFFIT  
BOARDS

BUILDING

ACCES  
TRAP DOOR

VENTILATION

SURFACE DRAINAGE  
PRODUCTS

HYDRAULIC  
DRAINAGE CHANNELS

ENVIRONMENT

HYDRAULIC  
DRAINAGE CHANNELS

SAUL

DRAINAGE FITTINGS

# FLOOR DRAINS AND SHOWER CHANNELS

## Shower channels **DOCIA** SYSTEMS

LENGTH (mm)			WIDTH (mm)			WIDTH (mm)	REF.	Packing	Packaging
Body	Frame	Grating	Body	Frame	Grating	Mini shower			

### COMPLETE CHANNELS WITH 50 MM WIDE REVERSIBLE MODEL GRATING

**50 mm water seal - 0.66 litres/second flow rate - Solvent weld Ø 40 mm socketoutlet or to screw**

Supplied with body, flange, screws, studs to adjust height of frame and grating, adjustment feet, trap, frame and 304 stainless steel reversible model grating for the full model.

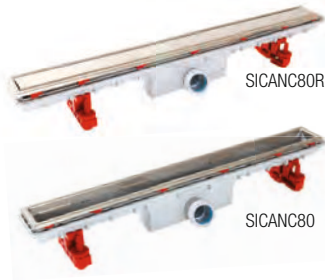

790	770	745	95	75	47	800	<b>SICANC80R</b>	B1	
CHANNEL BODY WITHOUT GRATING									
390	370		95	75			<b>SICANC40</b>	B1	
690	670		95	75		700	<b>SICANC70</b>	B1	
790	770		95	75		800	<b>SICANC80</b>	B1	
890	870		95	75		900	<b>SICANC90</b>	B1	
990	970		95	75		1000	<b>SICANC100</b>	B1	

## Low-height shower channels **DOCIA** SYSTEMS

LENGTH (mm)			WIDTH (mm)			REF.	Packing	Packaging
Body	Frame	Grating	Body	Frame	Grating			

### COMPLETE CHANNELS WITH 50 MM WIDE REVERSIBLE GRATING

**30 mm water seal + check valve - 0,44 litres/second flow rate - Solvent weld Ø 40 mm socketoutlet or to screw.** Supplied with body, flange, screws, studs to adjust height of frame and grating, trap, frame and 304 stainless steel reversible grating for the full model.

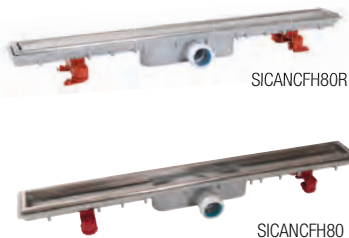

790	770	745	95	75	47	800	<b>SICANCFH80R</b>	B1	
CHANNEL BODY WITHOUT GRATING									
690	670		95	75		700	<b>SICANCFH70</b>	B1	
790	770		95	75		800	<b>SICANCFH80</b>	B1	
890	870		95	75		900	<b>SICANCFH90</b>	B1	
990	970		95	75		1000	<b>SICANCFH100</b>	B1	

## Sealing accessories

LENGTH (mm)	WIDTH (mm)	DESCRIPTION	REF.	Packing	Packaging
-------------	------------	-------------	------	---------	-----------

### SEALING

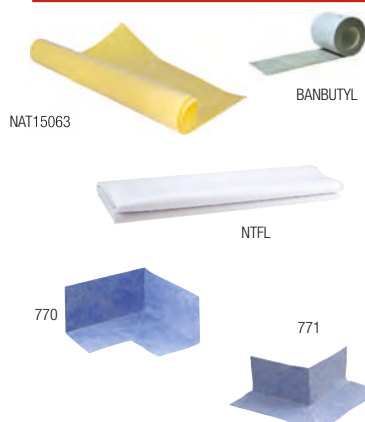

1500	630	Waterproofing membrane	<b>NAT15063</b>	S1	
10 000	150	Self-adhesive butyl sealant tape	<b>BANBUTYL</b>	F1	
1800	1500	<b>NTFL</b> , non-woven waterproofing membrane, water-repellent, ready-to-tile.	<b>0411703</b>	S1	
Moulded ready-to-bond corner seals					
		<b>770</b> , internal corner	<b>0411587</b>	S1	
		<b>771</b> , external corner	<b>0411588</b>	S1	

	LENGTH (mm)	WIDTH (mm)	COMPATIBILITY	WIDTH (mm) Mini shower	REF.	Packing	Packaging
<b>CRYSTAL GRATINGS, WIDTH 50 MM</b>							

The stainless steel frame surrounding the grating is supplied with the channel body.

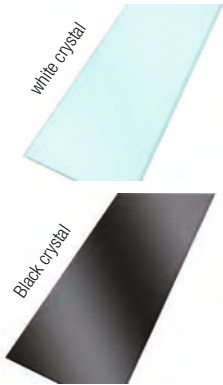

645	47	Grating for SICANC70	700	<b>GSICAN70BL</b>	B1		
745	47	Grating for SICANC80	800	<b>GSICAN80BL</b>	B1		
845	47	Grating for SICANC90	900	<b>GSICAN90BL</b>	B1		
945	47	Grating for SICANC100	1000	<b>GSICAN100BL</b>	B1		
645	47	Grating for SICANC70	700	<b>GSICAN70NO</b>	B1		
745	47	Grating for SICANC80	800	<b>GSICAN80NO</b>	B1		
845	47	Grating for SICANC90	900	<b>GSICAN90NO</b>	B1		
945	47	Grating for SICANC100	1000	<b>GSICAN100NO</b>	B1		

## 50 MM WIDE TYPE 304 STAINLESS STEEL GRATINGS, WIDTH 50 MM

The stainless steel frame surrounding the grating is supplied with the channel body.



345	47	Grating for SICANC40		<b>GSICAN40R</b>	B1		
645	47	Grating for SICANC70	700	<b>GSICAN70R</b>	B1		
745	47	Grating for SICANC80	800	<b>GSICAN80R</b>	B1		
845	47	Grating for SICANC90	900	<b>GSICAN90R</b>	B1		
945	47	Grating for SICANC100	1000	<b>GSICAN100R</b>	B1		
345	50	Grating for SICANC40		<b>GSICAN40C</b>	B1		
645	50	Grating for SICANC70	700	<b>GSICAN70C</b>	B1		
745	50	Grating for SICANC80	800	<b>GSICAN80C</b>	B1		
845	50	Grating for SICANC90	900	<b>GSICAN90C</b>	B1		
945	50	Grating for SICANC100	1000	<b>GSICAN100C</b>	B1		
345	50	Grating for SICANC40		<b>GSICAN40B</b>	B1		
645	50	Grating for SICANC70	700	<b>GSICAN70B</b>	B1		
745	50	Grating for SICANC80	800	<b>GSICAN80B</b>	B1		
845	50	Grating for SICANC90	900	<b>GSICAN90B</b>	B1		
945	50	Grating for SICANC100	1000	<b>GSICAN100B</b>	B1		
345	50	Grating for SICANC40		<b>GSICAN40F</b>	B1		
645	50	Grating for SICANC70	700	<b>GSICAN70F</b>	B1		
745	50	Grating for SICANC80	800	<b>GSICAN80F</b>	B1		
845	50	Grating for SICANC90	900	<b>GSICAN90F</b>	B1		
945	50	Grating for SICANC100	1000	<b>GSICAN100F</b>	B1		
345	50	Grating for SICANC40		<b>GSICAN40M</b>	B1		
645	50	Grating for SICANC70	700	<b>GSICAN70M</b>	B1		
745	50	Grating for SICANC80	800	<b>GSICAN80M</b>	B1		
845	50	Grating for SICANC90	900	<b>GSICAN90M</b>	B1		
945	50	Grating for SICANC100	1000	<b>GSICAN100M</b>	B1		

# FLOOR DRAINS AND SHOWER CHANNELS

## Shower channels with 70 mm gratings **DOCIA** SYSTEMS

	LENGTH (mm)		WIDTH (mm)		Code NR	REF.	Packing	Packaging
	Body	Grating	Body	Mini shower				

### CHANNEL BODIES WITHOUT GRATING AND FRAME

**50 mm water seal - 0,65 l/s flow rate - With Ø 40/50 mm connectors (socket outlet or to screw)**

Supplied without stainless steel grating and frame, with stainless steel body, studs to adjust height of frame, adjustment feet, TurboFlow drain with ball and socket, peripheral sealant membrane.



680	645	138	700	<b>CS06S</b>	<b>0205515</b>	B1	
780	745	138	800	<b>CS07S</b>	<b>0205516</b>	B1	
880	845	138	900	<b>CS08S</b>	<b>0205517</b>	B1	
980	945	138	1000	<b>CS09S</b>	<b>0205518</b>	B1	
1180	1145	138	1200	<b>CS0X</b>	<b>0205519</b>	B1	

## Systems shower channels with 70 mm gratings **DOCIA** SYSTEMS

	LENGTH (mm)		WIDTH (mm)		COMPATIBILITY	WIDTH (mm) Mini shower	REFERENCE	Packing	Packaging
	Frame	Grating	Frame	Grating					

### 70 MM WIDE TYPE 304 STAINLESS STEEL GRATINGS AND FRAMES

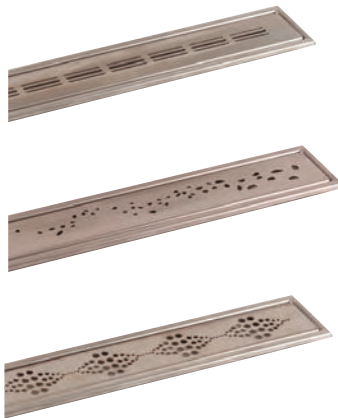

670	650	100	70	Grating for CS06S - CP61/CP62	700	<b>0245508</b>	B1	
870	850	100	70	Grating for CS08S	900	<b>0245509</b>	B1	
1170	1150	100	70	Grating for CS0X - CPX1	1200	<b>0245510</b>	B1	
670	650	100	70	Grating for CS06S - CP61/CP62	700	<b>0245500</b>	B1	
870	850	100	70	Grating for CS08S	900	<b>0245502</b>	B1	
1170	1150	100	70	Grating for CS0X - CPX1	1200	<b>0245504</b>	B1	
670	650	100	70	Grating for CS06S - CP61/CP62	700	<b>0245505</b>	B1	
840	850	100	70	Grating for CS08S	900	<b>0245506</b>	B1	
1170	1150	100	70	Grating for CS0X - CPX1	1200	<b>0245507</b>	B1	

# Systems shower channels with 70 mm gratings DOCIA SYSTEMS

	LENGTH (mm)	WIDTH (mm)	COMPTABILITY	WIDTH	Code NR	REF.	Packing	Packaging
				Mini shower				
<b>70 MM WIDETYPE 304 STAINLESS STEEL GRATINGS AND FRAMES</b>								
	645	70	Grating for CS06S - CP61/CP62	700	<b>GFL46</b>	<b>0411662</b>	B1	
	745	70	Grating for CS07S	800	<b>GFL47</b>	<b>0411663</b>	B1	
	845	70	Grating for CS08S	900	<b>GFL48</b>	<b>0411664</b>	B1	
	945	70	Grating for CS09S - CP91	1000	<b>GFL49</b>	<b>0411665</b>	B1	
	1145	70	Grating for CS0X - CPX1	1200	<b>GFL4X</b>	<b>0411666</b>	B1	
	645	70	Grating for CS06S - CP61/CP62	700	<b>GFL06</b>	<b>0411676</b>	B1	
	745	70	Grating for CS07S	800	<b>GFL07</b>	<b>0411677</b>	B1	
	845	70	Grating for CS08S	900	<b>GFL08</b>	<b>0411678</b>	B1	
	945	70	Grating for CS09S - CP91	1000	<b>GFL09</b>	<b>0411679</b>	B1	
	1145	70	Grating for CS0X - CPX1	1200	<b>GFL0X</b>	<b>0411680</b>	B1	
	645	70	Grating for CS06S - CP61/CP62	700	<b>GFL56</b>	<b>0411652</b>	B1	
	745	70	Grating for CS07S	800	<b>GFL57</b>	<b>0411653</b>	B1	
	845	70	Grating for CS08S	900	<b>GFL58</b>	<b>0411654</b>	B1	
	945	70	Grating for CS09S - CP91	1000	<b>GFL59</b>	<b>0411655</b>	B1	
	1145	70	Grating for CS0X - CPX1	1200	<b>GFL5X</b>	<b>0411656</b>	B1	
	645	70	Grating for CS06S - CP61/CP62	700	<b>GFL66</b>	<b>0411657</b>	B1	
	745	70	Grating for CS07S	800	<b>GFL67</b>	<b>0411658</b>	B1	
	845	70	Grating for CS08S	900	<b>GFL68</b>	<b>0411659</b>	B1	
	945	70	Grille pour CS09S - CP91	1000	<b>GFL69</b>	<b>0411660</b>	B1	
	1145	70	Grating for CS0X - CPX1	1200	<b>GFL6X</b>	<b>0411661</b>	B1	
	645	70	Grating for CS06S - CP61/CP62	700	<b>GFL76</b>	<b>0411686</b>	B1	
	745	70	Grating for CS07S	800	<b>GFL77</b>	<b>0411687</b>	B1	
	845	70	Grating for CS08S	900	<b>GFL78</b>	<b>0411688</b>	B1	
	945	70	Grating for CS09S - CP91	1000	<b>GFL79</b>	<b>0411689</b>	B1	
	645	70	Grating for CS06S - CP61/CP62	700	<b>GFLW6</b>	<b>0411698</b>	B1	
	745	70	Grating for CS07S	800	<b>GFLW7</b>	<b>0411699</b>	B1	
	845	70	Grating for CS08S	900	<b>GFLW8</b>	<b>0411700</b>	B1	
	945	70	Grating for CS09S - CP91	1000	<b>GFLW9</b>	<b>0411701</b>	B1	
	645	70	Grating for CS06S - CP61/CP62	700	<b>GFL86</b>	<b>0411690</b>	B1	
		745	70	Grating for CS07S	800	<b>GFL87</b>	<b>0411691</b>	B1
845		70	Grating for CS08S	900	<b>GFL88</b>	<b>0411692</b>	B1	
945		70	Grating for CS09S - CP91	1000	<b>GFL89</b>	<b>0411693</b>	B1	
645		70	Grating for CS06S - CP61/CP62	700	<b>GFL96</b>	<b>0411694</b>	B1	
		745	70	Grating for CS07S	800	<b>GFL97</b>	<b>0411695</b>	B1
	845	70	Grating for CS08S	900	<b>GFL98</b>	<b>0411696</b>	B1	
	945	70	Grating for CS09S - CP91	1000	<b>GFL99</b>	<b>0411697</b>	B1	

**SANITARY**

SANITARY

GLUE

RAINGUTTERS

ROOFING  
ACCESSORIES

FASCIA AND  
ROOFING SOFFIT  
BOARDS

**BUILDING**

ACCES  
TRAP DOOR

VENTILATION

SURFACE DRAINAGE  
PRODUCTS

HYDRAULIC  
DRAINAGE CHANNELS

**ENVIRONMENT**

HYDRAULIC  
DRAINAGE CHANNELS

SAJL

DRAINAGE FITTINGS



## FLOORLINE® SHOWER CHANNEL WIDTH 70 MM

### FLOORLINE® SHOWER CHANNEL LENGTH 500 MM



#### TECHNICAL FEATURES

Materials:

- Stainless steel grating
- Stainless steel shower channel

Dimensions:

- Dimensions: 101 mm
- Width: 80 mm
- Length: 500 mm

Connection:

- Waste:  $\varnothing$  40 mm screw or glue
- Sleeve:  $\varnothing$  50 mm horizontal stick
- 90 ° Elbow:  $\varnothing$  40/50 mm vertical stick
- Flow: 40 l /min at 20 mm water load

#### TOP ADVANTAGES

- Removable grating for an easy cleaning
- Stainless steel frame with adjustable stems
- Compact trap (height : 80 mm)
- 50 mm water seal

### FLOORLINE® SHOWER CHANNEL LENGTH 800 MM

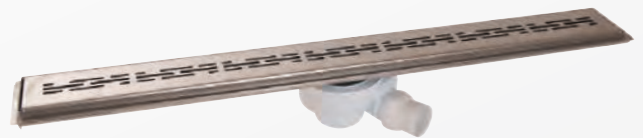

#### TECHNICAL FEATURES

Materials:

- Stainless steel grating
- Stainless steel shower channel

Dimensions:

- Dimensions: 101 mm
- Width: 80 mm
- Length: 800 mm

Connection:

- Waste:  $\varnothing$  40 mm screw or glue
- Sleeve:  $\varnothing$  50 mm horizontal stick
- 90 ° Elbow:  $\varnothing$  40/50 mm vertical stick
- Flow: 40 l /min at 20 mm water load

#### TOP ADVANTAGES

- Removable grating for an easy cleaning
- Stainless steel frame with adjustable stems
- Compact trap (height : 80 mm)
- 50 mm water seal

# FLOOR DRAINS AND SHOWER CHANNELS

## Shower channel Floorline®

	LENGTH (mm)		WIDTH (mm)		CODE NR	REF.	Packing	Packaging
	Body	Frame	Body	Frame				

### SHOWER CHANNELS WITH 500 MM SQUARE GRATING FLOORLINE®

**50 mm water seal - 0,66 litres/second flow rate - Solvent weld Ø 40/50 mm socket outlet or to screw**  
 Supplied with body an sealing flange, 304 stainless steel square grating design, anchor brackets and adjustment, plate, sleeve Ø 40/50 reduction, elbow vertical connection Ø 40/50



500	496	80	76	<b>CS50S</b>	<b>0205524</b>	<b>B1</b>	

### SHOWER CHANNELS WITH 800 MM SQUARE GRATING FLOORLINE®

**50 mm water seal - 0,66 litres/second flow rate - Solvent weld Ø 40/50 mm socket outlet or to screw**  
 Supplied with body and sealing flange plate recovery, 304 stainless steel square grating design, anchor brackets and adjustment, plate, sleeve Ø 40/50 reduction, elbow vertical connection Ø 40/50



800	796	80	76	<b>CS80S</b>	<b>0205525</b>	<b>B1</b>	

**50 mm water seal - 0,66 litres/second flow rate - Solvent weld Ø 40/50 mm socket outlet or to screw**  
 Supplied with Flange body sealing recovery, 304 stainless steel Lines grating design, anchor brackets and adjustment, plate, sleeve Ø 40/50 reduction, elbow vertical connection Ø 40/50



800	796	80	76	<b>C80</b>	<b>0205546</b>	<b>B1</b>	

## Shallow channel

	DESCRIPTION	REF.	Packing	Packaging
--	-------------	------	---------	-----------

### SHALLOW CHANNEL

**28 mm water seal - Ø 93 mm sealable PVC body in a Ø 100 mm PVC tube**

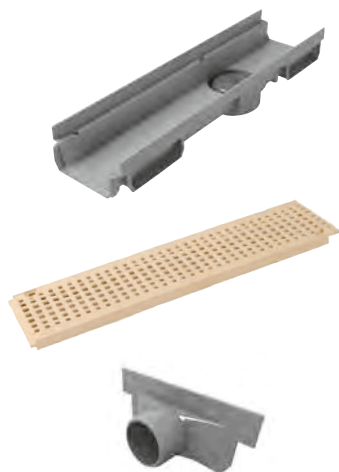

<b>Channel lenght 0,5 m with trap with outlet 40 and 50</b>	<b>CABS773</b>			6
<b>Grating for shallow channels</b> other gratings : see Hydraulic drainage channels	<b>GR77PS</b>			12
<b>End or lateral outlet Ø 40</b>	<b>NAH773</b>			10

SANITARY

SANITARY

GLUE

RAINGUTTERS

ROOFING ACCESSORIES

FASCIA AND ROOFING SOFFIT BOARDS

BUILDING

ACCES TRAP DOOR

VENTILATION

SURFACE DRAINAGE PRODUCTS

HYDRAULIC DRAINAGE CHANNELS

ENVIRONMENT

HYDRAULIC DRAINAGE CHANNELS

SAUL

# FLOOR DRAINS AND SHOWER CHANNELS

## Ready-to-tile EPS shower boards **DOCIA**<sup>®</sup> SYSTEMS

	DESCRIPTION	REF.	Packing	Packaging
--	-------------	------	---------	-----------

### SHOWER BOARDS + CHANNEL BODY SETS WITHOUT GRATING AND FRAME

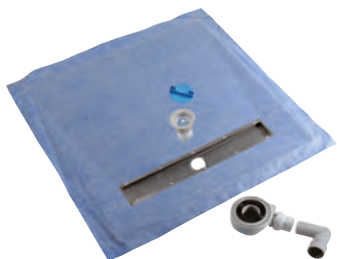

CP61

	DESCRIPTION	REF.	Packing	Packaging
	<b>Channel body + high density EPS board</b>			
	<b>CP61</b> , 90 x 90 x 5 cm for 650 mm stainless steel channel	<b>0205520</b>	C1	
	<b>CP62</b> , 90 x 180 x 5 cm for 650 mm stainless steel channel	<b>0205521</b>	C1	
	<b>CP91</b> , 120 x 120 x 5 cm for 950 mm stainless steel channel	<b>0205522</b>	C1	
	<b>CPX1</b> , 150 x 150 x 5 cm for 1150 mm stainless steel channel	<b>0205523</b>	C1	

### CHANNEL SHOWER BOARDS ALONE WITH SEALING MEMBRANE

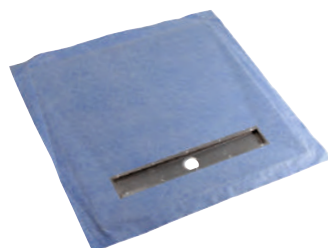

	DESCRIPTION	REF.	Packing	Packaging
	<b>High density EPS board only for use with a Nicoll Turbosol trap</b>			
	90 x 90 x 5 cm board for 650 mm stainless steel channel	<b>9871406</b>	C1	
	90 x 180 x 5 cm board for 650 mm stainless steel channel	<b>9871407</b>	C1	
	120 x 120 x 5 cm board for 950 mm stainless steel channel	<b>9871408</b>	C1	
	150 x 150 x 5 cm board for 1150 mm stainless steel channel	<b>9871409</b>	C1	

### CHANNEL SHOWER BOARDS ALONE WITH SEALING MEMBRANE

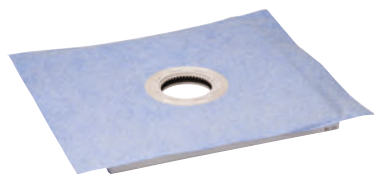

	DESCRIPTION	REF.	Packing	Packaging
	<b>High density EPS board only for use with a Nicoll Turbosol trap</b>			
	90 x 90 x 4 cm board	<b>9871400</b>	C1	
	100 x 100 x 4,2 cm board	<b>9871401</b>	C1	
	120 x 120 x 4,5 cm board	<b>9871402</b>	C1	
	90 x 120 x 4,5 cm board	<b>9871410</b>	C1	
	150 x 120 x 5 cm board	<b>9871403</b>	C1	
	180 x 90 x 4,2 cm board	<b>9871404</b>	C1	
	150 x 150 x 5 cm board	<b>9871405</b>	C1	



Ready-to-tile shower boards DOCIA<sup>®</sup> SYSTEMS

**Turbosol** DESCRIPTION REF. Packing Packaging  
**TURBOSOL TRAPS FOR READY-TO-TILE SHOWER BOARD**



<b>Only for use with Nicoll EPS shower board</b>			
Horizontal outlet drain	9886398	B1	
Vertical outlet	9887635	B1	
Horizontal outlet for channel shower board	9887249	B1	

**Turbosol** DESCRIPTION CODE NR REF. Packing Packaging  
**GRATINGS FOR TURBOSOL BOARDS AND FILM**

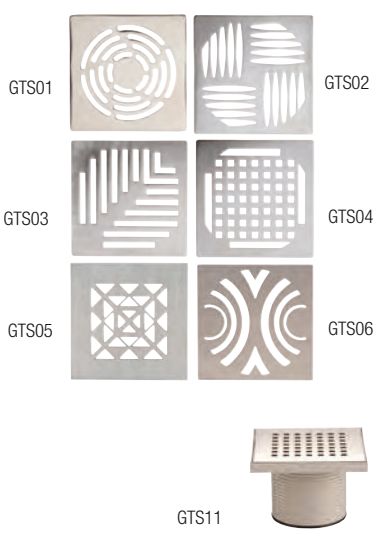

<b>Gratings for TURBOSOL drains</b>			
100 x 100 designer gratings, 3 mm thick stainless steel (Grating 0411572: standard grating supplied with Turbosol board and Turbosol water-tight film)	GTS01	0411572	K1
	GTS02	0411573	K1
	GTS03	0411574	K1
	GTS04	0411575	K1
	GTS05	0411576	K1
	GTS06	0411577	K1
150 x 150 designer grating with grating bracket, suitable for Turbosol water-tight film, 3 mm thick stainless steel	GTS11	0411623	B1

DESCRIPTION REF. Packing Packaging  
**SEALING - ACCESSORIES**

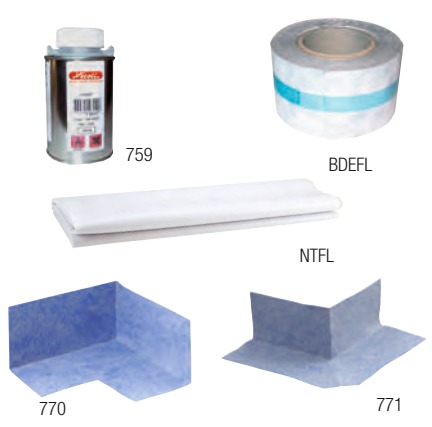

<b>Drain accessories with EPS BOARDS</b>			
BDEFL, self-adhesive corner sealant tape, 10 m x 8 cm roll with split release liner, ready-to-tile	0411681	B1	
759, adhesive for installation of drains with water-tight film	0411537	B1	
NTFL, 1,5 x 1,8 m non-woven sealing membrane, water-repellent, ready-to-tile	0411703	S1	
<b>Moulded ready-to-bond corner seals</b>			
770, internal corner	0411587	S1	
771, external corner	0411588	S1	



## READY-TO-TILE PP ALVEOLAR SHOWER BOARDS

### WITH FLOOR DRAINS



The alveolar structure of this shower board is exceptionally resistant to compression and is particularly suited to small mosaic tiles even when subject to wheelchair traffic.

- Resistant to compression: 1,3 N/mm<sup>2</sup>
- Floor drains with Ø 50 mm horizontal or Ø 50/63 mm vertical outlet
- The alveolar structure makes it light but resistant, particularly suited to small mosaic tiles
- Sealant-coated surface for direct application of tile adhesive
- 15 x 15 cm brushed type 304 stainless steel, White PVC or type 316 stainless steel grating
- Type 304 stainless steel, white PVC or Type 316 stainless steel frame



- Solvent welding connection
- Optional lockable grating
- Flow rates: Ø 50 mm = 1,2 l/s in vertical outlet
- Flow rates: Ø 50 mm = 0,8 l/s in horizontal outlet

#### Dimensions

90 x 90 x 4 cm

120 x 90 x 4,2 cm

120 x 120 x 4,5 cm

Gratings	Load class
15 x 15 cm stainless steel	K 3
15 x 15 cm PVC	K 3



# FLOOR DRAINS AND SHOWER CHANNELS

Ready-to-tile shower boards **DOCIA** SYSTEMS

	DESCRIPTION	REF.	Packing	Packaging
--	-------------	------	---------	-----------

## SHOWER BOARDS WITH 15 X 15 CM FLOOR DRAIN GRATING

**Shower boards: light, strong alveolar structure - direct application of tile adhesive.  
Floor drains: 50 mm water seal - PVC body - 304 stainless steel grating and frame - height adjustable.**



Horizontal outlet



Vertical outlet

<b>90 x 90 cm shower board with 15 x 15 cm floor drain grating</b>				
Ø 50 mm horizontal outlet - 0,8 l/s flow rate	<b>RAC99IH</b>	C1		
Ø 50/63 mm vertical outlet - 1,2 l/s flow rate	<b>RAC99IV</b>	C1		
<b>120 x 90 cm shower board with 15 x 15 cm floor drain grating</b>				
Ø 50 mm horizontal outlet - 0,8 l/s flow rate	<b>RAC129IH</b>	C1		
Ø 50/63 mm vertical outlet - 1,2 l/s flow rate	<b>RAC129IV</b>	C1		
<b>120 x 120 cm shower board with 15 x 15 cm floor drain grating</b>				
Ø 50 mm horizontal outlet - 0,8 l/s flow rate	<b>RAC1212IH</b>	C1		
Ø 50/63 mm vertical outlet - 1,2 l/s flow rate	<b>RAC1212IV</b>	C1		

## SHOWER BOARDS



RAC99

**Only for use with Nicoll SRAC type floor drains**

<b>90 x 90 cm shower board</b>	<b>RAC99</b>	B1		
<b>120 x 90 cm shower board</b>	<b>RAC129</b>			
<b>120 x 120 cm shower board</b>	<b>RAC1212</b>	B1		

## FLOOR DRAINS FOR READY-TO-TILE SHOWER TRAYS



SRAC15IH

**Only for use with Nicoll RAC type ready-to-tile shower board**

Ø 50 mm, horizontal outlet 0,8 l/s flow rate (15 x 15 cm grating)	Type 304 stainless steel grating	<b>SRAC15IH</b>	C1	
	Type 316 stainless steel grating	<b>SRAC15I316H</b>	C1	
Ø 50/63 mm, vertical outlet 1,2 l/s flow rate (15 x 15 cm grating)	Type 304 stainless steel grating	<b>SRAC15IV</b>	C1	
	Type 316 stainless steel grating	<b>SRAC15I316V</b>	C1	

## SEALING ACCESSORIES



**Flexible sealant tape**

<b>4 moulded corner seals</b> supplied in units of 4	<b>ANGRAC</b>	S1		
<b>Sealant tape</b> 10 ml x 0,10 ml roll	<b>BANRAC</b>	S1		
<b>Self-adhesive butyl sealant tape</b>	<b>BANBUTYL</b>	F1		

SANITARY

SANITARY

GLUE

RAINGUTTERS

ROOFING ACCESSORIES

FASCIA AND ROOFING SOFFIT BOARDS

BUILDING

ACCES TRAP DOOR

VENTILATION

SURFACE DRAINAGE PRODUCTS

HYDRAULIC DRAINAGE CHANNELS

ENVIRONMENT

HYDRAULIC DRAINAGE CHANNELS

SAUL



## FLOOR DRAINS FOR TILED FLOORINGS

### COMFORT TAKES PRIDE OF PLACE IN YOUR SHOWER ROOM...

The SICA floor drain is the ideal product for walk-in shower installations: for INDIVIDUAL SHOWERS/HOTELS/SPAS/COMMUNAL SHOWERS.















- Floor drains specifically designed for installation on tiled floors
- NF-Me reaction to fire classification for the PVC floor drains
- Guaranteed seal thanks to its flange + moulded sealing membrane system for easy installation
- Multipurpose floor drains (Ø 50 mm horizontal or Ø 50/63 mm vertical drain outlets)
- PVC, and 304 stainless steel or Type 316 stainless steel grating available in 10 x 10 cm and 15 x 15 cm sizes (optional lockable grating)
- Quick, safe installation
- Easy to clean
- Flow rates: Ø 50 mm = 1,20 l/s in vertical outlet 15x15 cm gratings
- Flow rates: Ø 50 mm = 1,10 l/s in vertical outlet 10x10 cm gratings
- Flow rates: Ø 50 mm = 0,8 l/s in horizontal outlet.

Gratings	Load class
10 x 10 cm stainless steel	H 1,5
15 x 15 cm stainless steel	K 3
10 x 10 cm PVC	K 3
15 x 15 cm PVC	K 3

# FLOOR DRAINS AND SHOWER CHANNELS

Floor drains for tiled flooring **DOCIA** SYSTEMS

	DESCRIPTION	REF.	Packing	Packaging
<b>FLOOR DRAINS FOR TILED FLOORING WITH 304 STAINLESS STEEL GRATINGS</b>				
<b>50 mm water seal - PVC body - stainless steel frame - height adjustable</b>				
<b>Floor drains for tiled floorings with stainless steel grating Ø 50 mm HORIZONTAL OUTLET</b>				
	Floor drain with 10 x 10 cm stainless steel grating - flow rate 0,8 l/s	<b>SICA10IH</b>	B1	
	Floor drain with lockable 10 x 10 cm stainless steel grating	<b>SICA10VH</b>	B1	
	Floor drain with 15 x 15 cm stainless steel grating - flow rate 0,8 l/s	<b>SICA15IH</b>	B1	
	Floor drain with lockable 15 x 15 cm stainless steel grating	<b>SICA15VH</b>	B1	
<b>Floor drains for tiled floorings with stainless steel grating Ø 50/63 mm VERTICAL OUTLET</b>				
	Floor drain with 10 x 10 cm stainless steel grating - flow rate 1,1 l/s	<b>SICA10IV</b>	B1	
	Floor drain with lockable 10 x 10 cm stainless steel grating	<b>SICA10VV</b>	B1	
	Floor drain with 15 x 15 cm stainless steel grating - flow rate 1,2 l/s	<b>SICA15IV</b>	B1	
	Floor drain with lockable 15 x 15 cm stainless steel grating	<b>SICA15VV</b>	B1	
<b>FLOOR DRAINS FOR TILED FLOORING WHITE PVC GRATING </b>				
<b>50 mm water seal - PVC body - adjustable height</b>				
<b>Floor drains for tiled flooring with white PVC grating Ø 50 mm HORIZONTAL OUTLET</b>				
	Floor drain with 10 x 10 cm PVC grating - flow rate 0,8 l/s	<b>SICA10H</b>	B1	
	Floor drain with 15 x 15 cm PVC grating - flow rate 0,8 l/s	<b>SICA15H</b>	B1	
	Floor drain with 15 x 15 cm PVC grating and 20 x 20 cm plate flow rate 0,8 l/s	<b>SICA215H</b>	B1	
<b>Floor drains for tiled flooring with white PVC grating Ø 50/63 mm VERTICAL OUTLET</b>				
	Floor drain with 10 x 10 cm PVC grating - flow rate 1,1 l/s	<b>SICA10V</b>	B1	
	Floor drain with 15 x 15 cm PVC grating - flow rate 1,2 l/s	<b>SICA15V</b>	B1	
	Floor drain with 15 x 15 cm PVC grating and 20 x 20 cm plate flow rate 1,2 l/s	<b>SICA215V</b>	B1	
<b>FLOOR DRAINS FOR TILED FLOORS TYPE 316 STAINLESS STEEL GRATING</b>				
<b>50 mm water seal - PVC body - type 316 stainless steel frame - adjustable height</b>				
<b>Floor drains for tiled floors with type 316 stainless steel grating Ø 50 mm HORIZONTAL OUTLET</b>				
	Floor drain with 10 x 10 cm type 316 stainless steel grating flow rate 0,8 l/s	<b>SICA10I316H</b>	B1	
	Floor drain with 15 x 15 cm type 316 stainless steel grating flow rate 0,8 l/s	<b>SICA15I316H</b>	B1	
				
<b>Floor drains for tiled floors with type 316 stainless steel grating Ø 50/63 mm VERTICAL OUTLET</b>				
	Floor drain with 10 x 10 cm type 316 stainless steel grating flow rate 1,1 l/s	<b>SICA10I316V</b>	B1	
	Floor drain with 15 x 15 cm type 316 stainless steel grating flow rate 1,2 l/s	<b>SICA15I316V</b>	B1	
				

SANITARY

SANITARY

GLUE

RAINGUTTERS

ROOFING ACCESSORIES

FASCIA AND ROOFING SOFFIT BOARDS

BUILDING

ACCES TRAP DOOR

VENTILATION

SURFACE DRAINAGE PRODUCTS

HYDRAULIC DRAINAGE CHANNELS

ENVIRONMENT

HYDRAULIC DRAINAGE CHANNELS

SAUL

# FLOOR DRAINS AND SHOWER CHANNELS

## Shower corner drains

	REF.	Packing	Packaging
<b>CORNER SHOWER TRAP BODY WITHOUT GRATING</b>			

**50 mm trap seal - 0.66 litres/second flow rate - Solvent weld Ø 40 mm socket outlet or to screw.**

Supplied without stainless steel grating, with flange, screws, studs to adjust height of frame and grating, wall fastening plate, trap and 304 stainless steel frame.

**New !**



SITRIANC

**SITRIANC**

B1

### GRATINGS FOR TYPE 304 STAINLESS STEEL CORNER DRAINS

The stainless steel frame surrounding the grating is supplied with the trap body.  
Grating compatible with SITRIANC



**New !**

GSTRIAND

GSTRIANR

GSTRANS

**GSTRIANR**

B1

**GSTRIAND**

B1

**GSTRANS**

B1

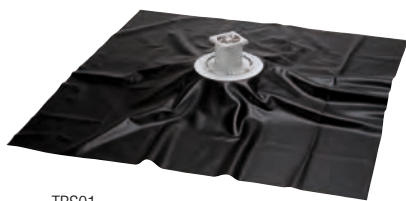

# PVC waterproofing membrane DOCIA<sup>®</sup> SYSTEMS

	DESCRIPTION	Ø	REF.	Packing	Packaging
<b>WATERPROOFING MEMBRANE + FLOOR DRAINS</b>					
 <b>Turbosol</b> <b>MEMBRANE</b>	<b>Floor drains with waterproofing membrane</b>				
	<b>TBS01</b> , with 120 x 120 cm waterproofing membrane	40	<b>0205391</b>	B1	
	<b>TBS02</b> , with 150 x 180 cm waterproofing membrane	40	<b>0205392</b>	B1	
	<b>TBS03</b> , with 180 x 210 cm waterproofing membrane	40	<b>0205393</b>	B1	
	<b>TBSF</b> , 180 x 120 cm waterproofing membrane without cut-out	40	<b>0411616</b>	B1	
	<b>TBS98</b> , made-to-measure waterproofing membrane	40	<b>0205468</b>		
	<b>TBS18</b> , with waterproofing membrane 120 x 120 cm and without head	50	<b>0205485</b>	B1	
	<b>TBS03K</b> , with waterproofing membrane 180 x 210 cm and without head	40-50	<b>0205427</b>	B1	
<b>TBS02K</b> , with waterproofing membrane 150 x 180 cm and without head	40-50	<b>0205426</b>	B1		



TBS01

# Floorline<sup>®</sup> drains

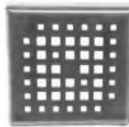
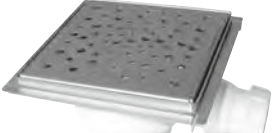
	DESCRIPTION	REF.	Packing	Packaging
<b>FLOORLINE<sup>®</sup> DRAINS</b>				
   	<b>ABS Floor drains</b> 10 x 10 cm without grating - 0,65 l/s flowrate - Ø 40 outlet	<b>0205550</b>	B1	
	<b>C10BG</b> , 10 x 10 cm grating in stainless steel bubble pattern	<b>0205551</b>		
	<b>C10SG</b> , 10 x 10 cm grating in stainless steel small square pattern	<b>0205552</b>		
	<b>ABS Floor drains</b> 15 x 15 cm stainless grating - 0,65 l/s flowrate - Ø 40 outlet	<b>0205549</b>	B1	

SANITARY

SANITARY

GLUE

RAINGUTTERS

ROOFING ACCESSORIES

FASCIA AND ROOFING SOFFIT BOARDS

BUILDING

ACCES TRAP DOOR

VENTILATION

SURFACE DRAINAGE PRODUCTS

HYDRAULIC DRAINAGE CHANNELS



ENVIRONMENT

HYDRAULIC DRAINAGE CHANNELS

SAUL





# FLOOR DRAINS AND SHOWER CHANNELS

## Floor drains for vinyl floors **DOCIA** SYSTEMS





	DESCRIPTION	REF.	Packing	Packaging
<b>FLOOR DRAINS FOR VINYL FLOORS WHITE PVC GRATING</b> 				
<b>50 mm water seal - PVC body</b>				
 SITAR	<b>Floor drain for vinyl floors with white PVC adjustable height grating</b> Ø 50/63 mm VERTICAL outlet - flow rate 1,3 l/s Ø 50 mm HORIZONTAL outlet - flow rate 1,1 l/s	<b>SITAR</b>	B1	D-6
	<b>Floor drain for vinyl floors with white PVC grating</b> Ø 50/63 mm VERTICAL outlet - flow rate 1,3 l/s in 50 mm version - 1,4 l/s in 63 mm version	<b>SITARV</b>	B1	
	<b>Floor drain for vinyl floors with white PVC grating</b> Ø 50 mm HORIZONTAL outlet - flow rate 0,8 l/s	<b>SITARH</b>	B1	
<b>Floor drains FOR VINYL FLOORS ALUMINIUM GRATING</b> 				
 SITARAL   SITARALV   SITARALH   ESITARAL	<b>Floor drain for vinyl floors with aluminium adjustable height grating</b> Ø 50/63 mm VERTICAL outlet - flow rate 1,2 l/s Ø 50 mm HORIZONTAL outlet - flow rate 0,9 l/s	<b>SITARAL</b>	B1	D-6
	<b>Floor drain for vinyl floors with aluminium grating</b> Ø 50/63 mm VERTICAL outlet - flow rate 1,3 l/s in 50 mm version - 1,4 l/s in 63 mm version	<b>SITARALV</b>	B1	
	<b>Floor drain for vinyl floors with aluminium grating</b> Ø 50 mm HORIZONTAL outlet - flow rate 0,8 l/s	<b>SITARALH</b>	B1	
	Aluminium grating + flange kit (supplied with 7 screws)	<b>ESITARAL</b>	S1	
<b>ACCESSORIES</b> 				
	<b>M/F Ø 125 extension piece</b>	<b>ZXSIT</b>		







# Floor drains

	DESCRIPTION	Ø	REF.	Packing	Packaging
<b>10 X 10 CM SQUARE GRATING FLOOR GULLIES</b> 					
<b>28 mm water seal - Ø 93 mm PVC body that can be sealed into Ø 100 mm PVC tube Suitable for use in walk-in showers, without seal</b>					
 SIHJ10CI  SIHJ10  SIHJ10I  ADSIHJ	<b>Ø 40/50 mm vertical outlet</b>				
	Floor trap with 10 x 10 cm stainless steel grating and frame		<b>SIHJ10CI</b>		D-10
	Floor trap with 10 x 10 cm stainless steel grating		<b>SIHJ10I</b>		D-10
	Floor trap with 10 x 10 cm white PVC grating		<b>SIHJ10</b>		D-10
	Floor trap with 10 x 10 cm PVC grating and frame, Ø 50 to glue or to screw	50	<b>SIJ10IV</b>		
	Horizontal outlet adaptor		<b>ADSIHJ</b>	C-10	D-10
	Floor trap with 10 x 10 cm stainless steel grid + adaptor		<b>SIHJ10IH</b>	C-10	D-10

## FLOOR DRAINS WITH ROUND GRATING AND PLATE

<b>Horizontal outlet - direction-adjustable plate</b>						
 SICH  PLC10FH  SIF  PL10FH	Floor drain	32	<b>SICF</b>	C-10		
	Floor drain	40	<b>SICH</b>	C-10		
	floor drain with horizontal outlet	50	<b>SICI</b>			
	100 x 100 plate		<b>PLC10FH</b>	S10		
	<b>Vertical outlet</b>					
	Floor drain	32	<b>SIF</b>	S1	D-10	
	Floor drain	40	<b>SIH</b>	S1	D-10	
	Floor drain	50	<b>SIJ</b>	S1	D-10	
	<b>Plates for floor drain:</b>					
	Ø 32 and 40 mm - dimensions 100 x 100		<b>PL10FH</b>	S10		
Ø 32 and 40 mm - dimensions 150 x 150		<b>PL15FH</b>	S10			
Ø 50 mm - dimensions 150 x 150		<b>PL15J</b>	S10			
Ø 50 mm - dimensions 200 x 200		<b>PL20J</b>	S10			
Ø 50 mm - dimensions 250 x 250		<b>PL25J</b>	S10			

## FLOOR GULLIES WITH MULTIPLE INLETS

<b>Multiple inlets Ø 50/50/60/63 mm direction-adjustable plate</b>						
 SEMX15  P4VST  P4VAST  TAPUSO	Plate dimensions 150 x 150		<b>SEMX15</b>		D-4	
	Plate dimensions 200 x 200		<b>SEMX20</b>		D-4	
	<b>From Ø 100 mm tubes with multiple inlets Ø 40/40/40/40-50 mm</b>					
	Low model		<b>P4VST</b>			
Tall model		<b>P4VAST</b>				
<b>Ø 100 mm removable plug Suitable for TPR valve drains</b>						
		<b>TAPUSO</b>	F20			

SANITARY

SANITARY

GLUE

RAINGUTTERS

ROOFING ACCESSORIES

FASCIA AND ROOFING SOFFIT BOARDS

BUILDING

ACCES TRAP DOOR

VENTILATION

SURFACE DRAINAGE PRODUCTS

HYDRAULIC DRAINAGE CHANNELS

ENVIRONMENT

HYDRAULIC DRAINAGE CHANNELS

SAUL

# FLOOR DRAINS AND SHOWER CHANNELS

## Floor drains

	DESCRIPTION	Ø	REF.	Packing	Packaging
--	-------------	---	------	---------	-----------

### BODY OF FLOOR GULLY WITH MULTIPLE INLETS



KFSEMX

Body 125 mm with 50 x 50 x 50 mm inlets and 63 mm outlet, 35 mm water seal	125	<b>KSEMVX</b>			
Body 125 mm with 40 x 40 x 40 mm inlets and 50 mm outlet, 30 mm water seal	125	<b>KSEMVG</b>			
Body 110 mm with 50 x 50 x 50 mm inlets and 50 mm outlet, 35 mm water seal	110	<b>KSEMV</b>			

### ACCESSORIES FOR THE ABOVE FLOOR GULLIES



PGSMX20

<b>Covers, light grey colour</b>					
Plate 15 x 15 cm with PVC grating		<b>PGSMX15</b>	S1		
Plate 20 x 20 cm with PVC grating		<b>PGSMX20</b>	S1		
Plate 15 x 15 cm with PVC cover		<b>PTSMX15</b>	S1		
Plate 20 x 20 cm with PVC cover		<b>PTSMX20</b>	S1		
Plate 15 x 15 cm with stainless steel grating and cover		<b>PISMX15</b>	S1		
Plate 20 x 20 cm with stainless steel grating and cover		<b>PISMX20</b>	S1		



PTSMX201

<b>Covers, ivory colour</b>					
Plate 15 x 15 cm with PVC grating		<b>PGSMX151</b>	S1		
Plate 20 x 20 cm with PVC grating		<b>PGSMX201</b>	S1		
Plate 15 x 15 cm with PVC cover		<b>PTSMX151</b>	S1		
Plate 20 x 20 cm with PVC cover		<b>PTSMX201</b>	S1		
Plate 15 x 15 cm with stainless steel grating and cover		<b>PISMX151</b>	S1		
Plate 20 x 20 cm with stainless steel grating and cover		<b>PISMX201</b>	S1		



PTSMX20B

<b>Covers, white colour</b>					
Plate 15 x 15 cm with PVC grating		<b>PGSMX15B</b>	S1		
Plate 20 x 20 cm with PVC grating		<b>PGSMX20B</b>	S1		
Plate 15 x 15 cm with PVC cover		<b>PTSMX15B</b>	S1		
Plate 20 x 20 cm with PVC cover		<b>PTSMX20B</b>	S1		
Plate 15 x 15 cm with stainless steel grating and cover		<b>PISMX15B</b>	S1		
Plate 20 x 20 cm with stainless steel grating and cover		<b>PISMX20B</b>	S1		

### ACCESSORIES



M/F Ø 125 extension piece

ZXSIT